



MPXone

Electronic control for refrigeration applications



USER MANUAL

→ LEGGI E CONSERVA
QUESTE ISTRUZIONI ←
READ AND SAVE
THESE INSTRUCTIONS

MPXone

+0300086EN - ENG

Up to date version available on

www.carel.com

GENERAL WARNINGS



CAREL bases the development of its products on decades of experience in HVAC/R, on continuous investments in technological innovations to products, procedures and strict quality processes with in-circuit and functional testing on 100% of its products, and on the most innovative production technology available on the market. CAREL and its subsidiaries/affiliates nonetheless cannot guarantee that all the aspects of the product and the software included with the product respond to the requirements of the final application, despite the product being developed according to start-of-the-art techniques. The customer (manufacturer, developer or installer of the final equipment) accepts all liability and risk relating to the configuration of the product in order to reach the expected results in relation to the specific final installation and/or equipment. CAREL may, based on specific agreements, act as a consultant for the successful commissioning of the final unit/application, however in no case does it accept liability for the correct operation of the final equipment/system. The CAREL product is a state-of-the-art product, whose operation is specified in the technical documentation supplied with the product or can be downloaded, even prior to purchase, from the website www.carel.com. Each CAREL product, in relation to its advanced level of technology, requires setup/configuration/programming/commissioning to be able to operate in the best possible way for the specific application. Failure to complete such operations, which are required/indicated in the user manual, may cause the final product to malfunction; CAREL accepts no liability in such cases. Only qualified personnel may install or carry out technical service on the product. The customer must only use the product in the manner described in the documentation relating to the product. In addition to observing any further warnings described in this manual, the following warnings must be heeded for all CAREL products:

- prevent the electronic circuits from getting wet. Rain, humidity and all types of liquids or condensate contain corrosive minerals that may damage the electronic circuits. In any case, the product should be used or stored in environments that comply with the temperature and humidity limits specified in the manual;
- do not install the device in particularly hot environments. Too high temperatures may reduce the life of electronic devices, damage them and deform or melt the plastic parts. In any case, the product should be used or stored in environments that comply with the temperature and humidity limits specified in the manual;
- do not attempt to open the device in any way other than described in the manual.
- do not drop, hit or shake the device, as the internal circuits and mechanisms may be irreparably damaged.
- do not use corrosive chemicals, solvents or aggressive detergents to clean the device.
- do not use the product for applications other than those specified in the technical manual.

All of the above suggestions likewise apply to the controllers, serial cards, programming keys or any other accessory in the CAREL product portfolio.

CAREL adopts a policy of continual development. Consequently, CAREL reserves the right to make changes and improvements to any product described in this document without prior warning. The technical specifications shown in the manual may be changed without prior warning. The liability of CAREL in relation to its products is specified in the CAREL general contract conditions, available on the website www.carel.com and/or by specific agreements with customers; specifically, to the extent where allowed by applicable legislation, in no case will CAREL, its employees or subsidiaries/affiliates be liable for any lost earnings or sales, losses of data and information, costs of replacement goods or services, damage to things or people, downtime or any direct, indirect, incidental, actual, punitive, exemplary, special or consequential damage of any kind whatsoever, whether contractual, extra-contractual or due to negligence, or any other liabilities deriving from the installation, use or impossibility to use the product, even if CAREL or its subsidiaries/affiliates are warned of the possibility of such damage.

DISPOSAL



INFORMATION FOR USERS ON THE CORRECT HANDLING OF WASTE ELECTRICAL AND ELECTRONIC EQUIPMENT (WEEE)

The product is made up of metal parts and plastic parts. In reference to European Union directive 2002/96/EC issued on 27 January 2003 and related national legislation, please note that:

- WEEE cannot be disposed of as municipal waste and such waste must be collected and disposed of separately;
- the public or private waste collection systems defined by local legislation must be used. In addition, the equipment can be returned to the distributor at the end of its working life when buying new equipment;
- the equipment may contain hazardous substances: the improper use or incorrect disposal of such may have negative effects on human health and on the environment;
- the symbol (crossed-out wheeled bin) shown on the product or on the packaging and on the instruction sheet indicates that the equipment has been introduced onto the market after 13 August 2005 and that it must be disposed of separately;
- in the event of illegal disposal of electrical and electronic waste, the penalties are specified by local waste disposal legislation.

Warranty on materials: 2 years (from production date, excluding consumables).



Approval: the quality and safety of CAREL S.p.A. products are guaranteed by the ISO 9001 certified design and production system.

IMPORTANT



Separate as much as possible the probe and digital input cables from cables to inductive loads and power cables, so as to avoid possible electromagnetic disturbance. Never run power cables (including the electrical panel cables) and signal cables in the same conduits.

Key to the symbols:

-  **Important:** to bring critical issues to the attention of those using the product.
-  **Note:** to focus attention on important topics; in particular the practical application of the various product functions.

 **Important:** This product is to be integrated and/or incorporated into the final apparatus or equipment. Verification of conformity to the laws and technical standards in force in the country where the final apparatus or equipment will be operated is the manufacturer's responsibility. Before delivering the product, Carel has already completed the checks and tests required by the relevant European directives and harmonised standards, using a typical test setup, which however cannot be considered as representing all possible conditions of the final installation.

HACCP: CAUTION



The Food Safety programs based on HACCP procedures and on certain national standards, require that the devices used for food preservation are periodically checked to make sure that the measuring errors are within the allowed limits of the application of use. Carel recommends compliance with the indications of European standard "Temperature recorders and thermometers for transport, storage and distribution of chilled, frozen, deep-frozen/quick-frozen food and ice cream – PERIODIC VERIFICATION ", EN 13486 -2001 (or subsequent updates) or similar standards and prescriptions applicable in the country of use. The manual contains further indications regarding technical feature, proper installation and configuration of the product.

Index

1. INTRODUCTION	7	6.1 Parameter table	85
1.1 Functions and main features	7	6.2 Configuring the MPXone controller via the APPLICA app	94
1.2 Models and accessories	8	7. TECHNICAL SPECIFICATIONS	96
2. INSTALLATION	12	7.1 Connector/cable table	98
2.1 Warnings	12	8. ALARMS AND SIGNALS	99
2.2 Panel version	12	8.1 Signals	99
2.3 DIN rail version	14	8.2 Types of alarms	99
2.4 Description of the terminals	14	8.3 Display alarm log	100
2.5 Probe connection	16	8.4 Alarm table	100
2.6 Connection diagrams	16	8.5 Alarm parameters	101
2.7 Positioning inside the panel	19	8.6 HACCP alarms	103
2.8 Electrical installation	19	9. RELEASE NOTES	106
2.9 Serial port connections	19		
2.10 Functional diagrams	20		
2.11 Installation	23		
2.12 SPARK: configuration and commissioning software	23		
2.13 Setting the default parameters/loading the parameter sets	24		
2.14 Applica: copy configuration	24		
2.15 Applica: date/time and time bands	25		
3. USER INTERFACE	26		
3.1 Introduction	26		
3.2 User terminal and remote display	27		
4. INITIAL CONFIGURATION	31		
4.1 Wizard	31		
4.2 APPLICA	31		
4.3 Description of the initial configuration parameters	32		
4.4 Checks after commissioning	36		
5. FUNCTIONS	37		
5.1 Inputs and outputs	37		
5.2 Control	51		
5.3 Defrost	61		
5.4 Evaporator fans	68		
5.5 Anti-sweat heater or fan modulation	71		
5.6 Electronic valve	73		
5.7 Compressor	83		
6. PARAMETER TABLE	84		

1. Introduction

MPXone is an electronic controller for centralised commercial refrigeration applications in which a group of showcases needs to operate in a coordinated manner. The user terminal allows wireless connectivity with mobile devices and is built-in on the panel mounted models, or sold separately on DIN rail mounted models. The range includes two versions, basic and medium, which differ regarding the number of inputs/outputs; both versions have Near Field Connection (NFC) as standard, while Bluetooth (BLE) is optional on the latter. Power supply is 24 Vac/dc for the panel-mounted models (basic and medium) and 230 Vac for DIN rail models (medium). CAREL's "APPLICA" app, available on Google Play for the Android operating system, makes it easier to configure parameters and commission the unit in the field.

The solution is completed by the "Spark" PC commissioning tool, used to manage user profiles, configure parameters and change descriptions of the variables. The possibility to use these two tools simultaneously, even by different users in separate locations - for example, modify a user profile with "Spark" in the technical office, and apply it to the system using "Applica", highlights the potential made available by the complete package.

1.1 Functions and main features

MPXone, which shares many of the features already available on the MPXPRO range of controllers, has been designed to offer maximum flexibility thanks to modular hardware. The medium version, compared to the basic version:

- has more analogue and digital inputs and two analogue outputs;
- can manage an external driver (via Fieldbus serial port) to drive an electronic expansion valve.

The functions that can be assigned for the various analogue inputs are those required to control the refrigeration unit temperature - outlet (air off), intake (air on) and defrost probes - plus control of superheat, saturated evaporation temperature, defrost on the second evaporator, ambient temperature and humidity and glass temperature. In addition, up to four virtual probes are available, physically connected to other devices and shared via the supervisor, and can be used to manage one of the specific functions listed above. The two analogue outputs available on the medium model can be used to control the speed of the evaporator fans and/or to modulate the anti-sweat heaters. The digital inputs can be used for day/night switching, defrost calls, the door or curtain switch or activating alarms and other special functions. The four digital outputs (relays) can be configured to control activation of the solenoid valve/compressor, evaporator fans, defrost, lights and/or alarms.

Main features:

- compact structure: panel and DIN rail version;
- 24 Vac/dc power supply for the panel version and 115/230 Vac for the DIN version;
- hardware equipped with two 0-10 V modulating outputs for managing anti-sweat heaters and evaporator fans (medium version);
- possibility to control an external driver for driving an electronic expansion valve (medium version);
- NFC wireless connectivity as standard (Bluetooth optional on the medium version);
- commissioning tool to optimise configuration of the controller;
- possibility to set-up a master/slave network (up to 9 slaves);
- integrated RS485 serial port for connection to supervisors and remote service systems (CAREL or Modbus protocol);
- Smooth Lines function for modulating evaporator capacity according to cooling demand (medium version);
- advanced superheat control with low superheat (LowSH), low/high evaporation temperature (LOP/MOP) and low suction temperature (LSA) protection;
- defrost activated via keypad, digital input, network signal from Master, supervisor or scheduled with built-in RTC;
- management of various types of defrosts, on one or two evaporators: heater, natural (compressor off)
- smart defrost functions;
- coordination of network defrosts;
- management of cabinet lights and curtain;
- digital input broadcast from Master to Slaves;
- display of Slave alarms on Master;
- sharing of one or more network probes;

- Master gateway to supervisor for all Slaves;
- HACCP alarm management.

Example of operation with one evaporator on a vertical showcase:

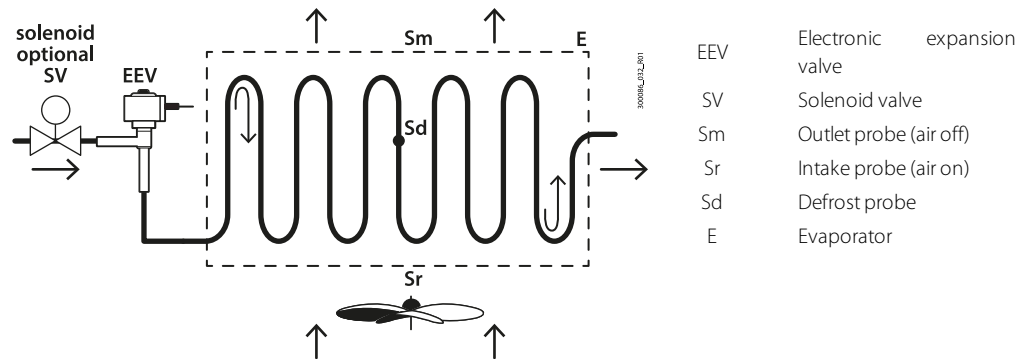

Fig.1.a

1.2 Models and accessories

The single-pack versions come with connector kits, while the multiple pack versions are supplied without connectors. The table below shows the list of part numbers and distinctive features for the basic and medium versions.



Fig.1.b

P/N	Description
S1M0004W0B060	Basic panel 24V, NFC, with connectors, single pack
S1M0004W00061	Basic panel 24V, NFC, without connectors, multiple pack (20 pcs.)
S1M0006W0B070	24V panel medium, NFC, with connectors, single pack
S1M0006W00071	24V panel medium, NFC, without connectors, multiple pack (20 pcs.)
S1M0006B0B080	Medium panel 24V, NFC+BLE, with connectors, single pack
S1M0006B00081	24V panel medium, NFC+BLE, without connectors, multiple pack (20 pcs.)
S1M0007N0B110	DIN Medium, 115/230V, with connectors, single package
S1M0007N00111	DIN Medium, 115/230V, without connectors, multiple pack (10 pcs.)

Tab.1.a

User terminal and remote display

- The user terminal is available for DIN rail mounted models (it is built-in on the panel model). The user terminal includes the display and keypad, comprising four buttons that, when pressed alone or combined with other buttons, are used to display and set the controller's parameters (see "User interface"). Connectivity - NFC or NFC + Bluetooth (BLE) based on the model - allows interaction with mobile devices and simplifies unit commissioning (after having installed the CAREL "Applica" APP for the Android operating system)
- The remote display can be connected as an accessory on both the panel model and the DIN rail model. This is a display only, used to show alarms and one selected temperature value, with the corresponding unit of measure, °C or °F.

See the chap. "Installation" in the technical leaflet +0500142IE.



Fig.1.c

P/N	Description
AX3000PS2002(0/1)(*)	User terminal, NFC, 4 buttons, buzzer
AX3000PS2003(0/1)(*)	User terminal, NFC+BLE, 4 buttons, buzzer
AX3000PS20X1(0/1)(*)	Remote display
ACS00CB000010	User terminal cable - 3 m long
(0/1)(*): single/multiple pack (20 pcs.)	

Tab.1.b

Cable and connector kit

Controllers in multiple packs are supplied without connectors. Depending on the version of the controller, see the table below.

P/N	Description
ACS00CK001301	Connector kit for Basic controller (10 pcs.)
ACS00CK001401	Connector kit for Medium controller (10 pcs.)
ACS00CB000230	Kit of 10 coloured cables with lugs, 1 m (J2)
ACS00CB000330	Kit of 8 coloured cables with lugs, 3 m (J3)

1.2.1 Temperature sensors

The temperature probe must be installed close to the evaporator outlet, according to the usual installation procedures (see the E2V technical leaflet). Suitable thermal insulation of the probes is recommended.

CAREL supplies probes designed to simplify installation in contact with the refrigerant piping:



Fig.1.d

P/N	Type	Description	Range
NTC060HP00	10 kΩ ±1% @25°C, IP67	Cabinet ambient temperature probe	-50 to 50 °C (105°C in air)
NTC***HF01	10 kΩ ±1% @25°C, IP67	Evaporator outlet temperature probe	-50 to 90°C strap-on
NTC060WG00		Glass temperature probe	
D PWC111000	4-20 mA	Ambient temperature and humidity probe	
DPWC115000	0 to 10 Vdc		

Note:

- the glass temperature probe must be connected to the coldest point of the showcase glass, for optimum operation of the anti-sweat device (heaters or fans). See the instruction sheet +050002005
- see manual +040010025 (ITA- ENG) /+040010026 (FRE-GER) for guidelines on installing the sensors on the unit.

1.2.2 Pressure sensors

To measure the saturated evaporation temperature, different types of probes can be used, in particular (parameter /P2) the following:

- 0-5 V ratiometric pressure probe (recommended by CAREL);
- 4-20 mA active pressure probes.



Fig.1.e

P/N	Type	Description	Range
SPKT0013R0	0-5V	Evaporation pressure probe	-1 to 9.3
SPKT0053R0	0-5V		-1 to 4.2
SPKT0043R0	0-5V		0 to 17.3
SPKT0033R0	0-5V		0 to 34.5
SPKT00B6R0	0-5V		0 to 45.0
SPKT0011S0	0-5V		-1 to 9.3
SPKT0041S0	0-5V		0 to 17.3
SPKT0031S0	0-5V		0 to 34.5
SPKT00B1S0	0-5V		0 to 45.0
SPKT00G1S0	0-5V		0 to 60.0

Note: see manual +040010025 (ITA- ENG) /+040010026 (FRE-GER) for guidelines on installing the sensors on the unit.

Electronic expansion valve driver

The medium version can control an external driver (EVDmini, EVDice) to drive a unipolar electronic expansion valve, connected to the Fieldbus serial port (J5 FBus).

See manuals +0300036EN, +0300038EN.



Fig.1.f

P/N	Description
EVDM000N00	EVD MINI 24V without display
EVDM010N00	EVD MINI 115/230V without display
EVDM011R3*	EVD ice 115/230 V, E2V stator, display
EVDM011R1*	EVD ice 115/230 V, E2V stator, display, Ultracap module connector
EVDM011R4*	EVD ice 115/230 V, E3V stator, display
EVDM011R2*	EVD ice 115/230 V, E3V stator, display, Ultracap module connector

(*): 0/1=single/multiple pack (10 pcs.)

Tab.1.c

Transformer

For the panel model.

P/N	Description
TRA00AE24(0/1)*	230V-24V 10VA panel transformer for Basic model

(*)(0/1): single/multiple pack (10 pcs.)

Tab.1.d

Note: the power consumption of the Medium model may require a larger transformer.

1.2.3 USB/RS485 converter (CVSTDUMOR0)

Electronic device used to interface an RS485 network to a personal computer via the USB port. See the technical leaflet +050000590.



Fig.1.g

2. Installation

2.1 Warnings

- ⚠ Important:** avoid installing the controller in environments with the following characteristics:
- temperature and humidity that do not comply with the ambient operating conditions (see "Technical specifications");
 - strong vibrations or knocks;
 - exposure to water sprays or condensate;
 - exposure to aggressive and polluting atmospheres (e.g.: sulphur and ammonia gases, saline mist, smoke) which may cause corrosion and/or oxidation;
 - strong magnetic and/or radio frequency interference (thus avoid installation near transmitting antennae);
 - exposure to direct sunlight and the elements in general;
 - wide and rapid fluctuations in ambient temperature;
 - exposure to dust (formation of corrosive patina with possible oxidation and reduction of insulation).

2.2 Panel version

2.2.1 Dimensions – mm(in)

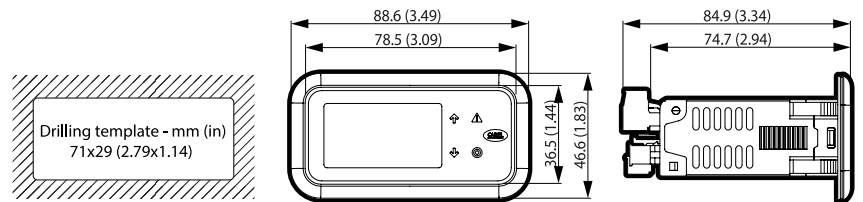

Fig.2.a

Removing the frame

- 👉 Note:** the panel version is supplied with the frame already fitted. Nonetheless, this can be easily removed without affecting the IP protection rating.

Press the frame gently upwards at one of the points indicated by the arrows in the figure until hearing a click, and repeat the operation at the other points so as to detach the frame.

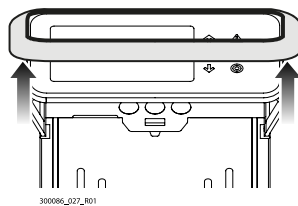

Fig.2.b

2.2.2 Mounting

⚠ Important: before carrying out any maintenance, disconnect the controller from the power supply by moving the main system switch to "off".

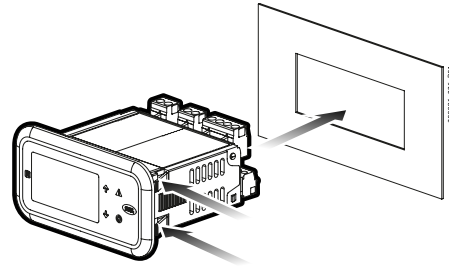

Fig.2.c

1. Place the controller in the opening, pressing lightly on the side anchoring tabs.
2. Then press on the front until fully inserted (the side tabs will bend, and the catches will attach the controller to the panel).

⚠ Important: IP65 front protection is guaranteed only if the following conditions are met:

- maximum deviation of the rectangular opening from flat surface: ≤ 0.5 mm;
- thickness of the electrical panel sheet metal: 0.8-2 mm;
- maximum roughness of the surface where the gasket is applied: ≤ 120 μ m.

➡ Note: the thickness of the sheet metal (or material) used to make the electrical panel must be adequate to ensure safe and stable mounting of the product.

2.2.3 Removal

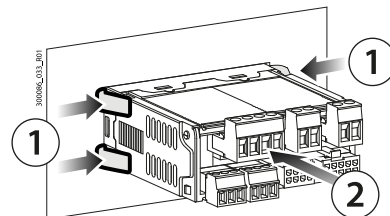

Fig.2.d

Open the electrical panel and from the rear:

1. gently press the side anchoring tabs on the controller;
2. exert slight pressure on the controller until it is removed.

⚠ Important: the operation does not require the use of a screwdriver or other tools.

2.3 DIN rail version

2.3.1 Dimensions – mm(in)

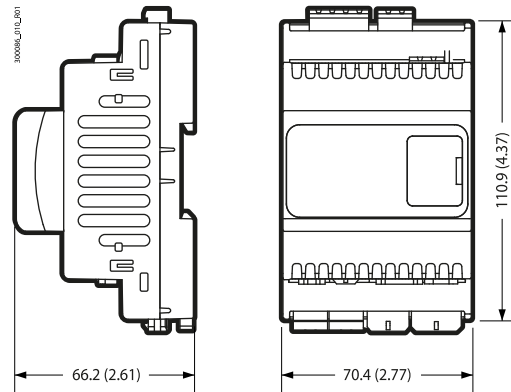

Fig.2.e

2.3.2 Mounting

Apply slight pressure to the controller resting on the DIN rail until the rear tab clicks into place.

2.3.3 Removal

Use a screwdriver as a lever in the hole to lift and release the tab. The tab is held in the locked position by return springs.

2.4 Description of the terminals

Panel model

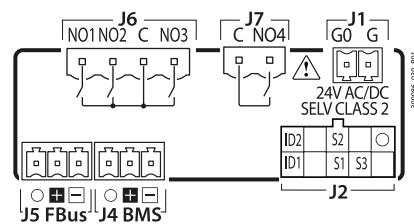

basic

Fig.2.f

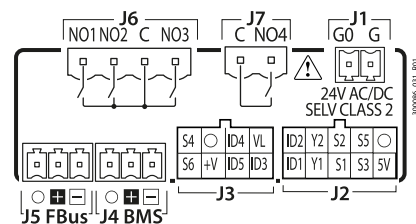

medium

Fig.2.g

DIN rail model

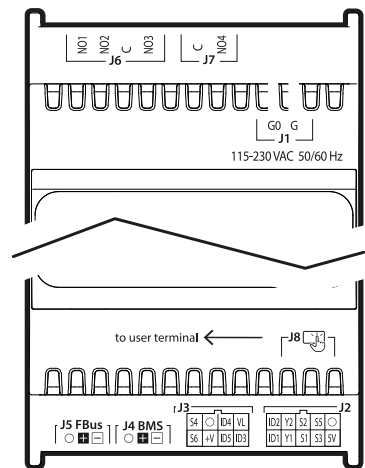

Fig.2.h

Ref.		Description	Cable kit colour
J1	G	Power supply	-
	G0	Power supply: reference	-
J2	5V	Ratiometric probe power supply	white
	S3	Analogue input 3	brown
	S1	Analogue input 1	green
	Y1	Analogue output 1	yellow
	ID1	Digital input 1	grey
	O	GND: reference for probes, digital inputs and analogue outputs	pink
	S5	Analogue input 5	blue
	S2	Analogue input 2	red
	Y2	Analogue output 2	black
	ID2	Digital input 2	purple
J3	ID3	Digital input 3	white
	ID5	Digital input 5	brown
	+V	Power supply to 4-20 mA active probes	green
	S6	Analogue input 6	yellow
	VL	remote display power supply	grey
	ID4	Digital input 4	pink
	O	GND	blue
	S4	Analogue input 4	red
J4	-	BMS serial port (RS485): Rx/Tx-	
	+	BMS serial port (RS485): Rx/Tx+	
	O	BMS serial port (RS485): GND	
J5	-	Fieldbus serial port (RS485): Rx/Tx -	
	+	Fieldbus serial port (RS485): Rx/Tx +	
	O	Fieldbus serial port (RS485): GND	
J6	C	Common for relays 1, 2, 3	
	NO1	Digital output (relay) 1	
	NO2	Digital output (relay) 2	
	NO3	Digital output (relay) 3	
J7	C	Common for relay 4	
	NO4	Digital output (relay) 4	
J8	-	Remote terminal connector (DIN version only)	

Tab.2a

2.5 Probe connection

Note: the probe connections relate to the default parameter configuration.

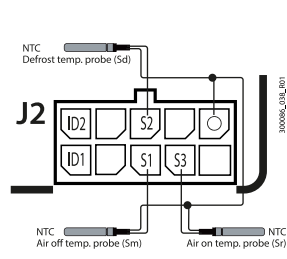

basic panel

Fig.2.i

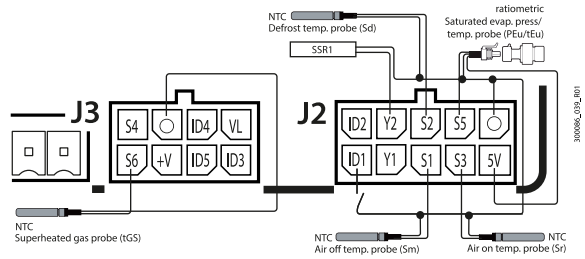

medium

Fig.2.j

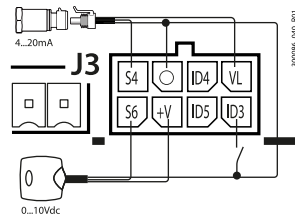

Possible connections

Note: O = GND

Fig.2.k

2.6 Connection diagrams

Note: the "APPLICA" application can be used to change the configuration of the probes without needing to rewire or change the functions of the relays, thus taking advantage of different capacities when needed.

2.6.1 Panel model

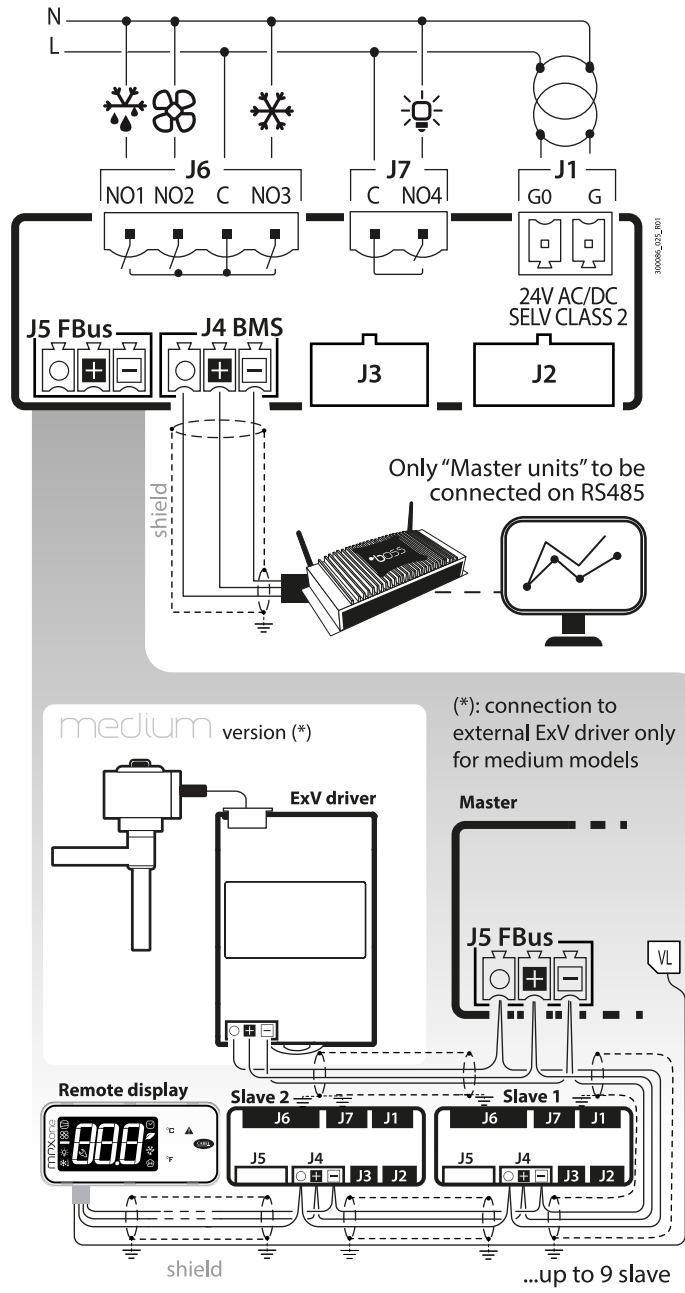

Fig.2.I

2.6.2 DIN rail model

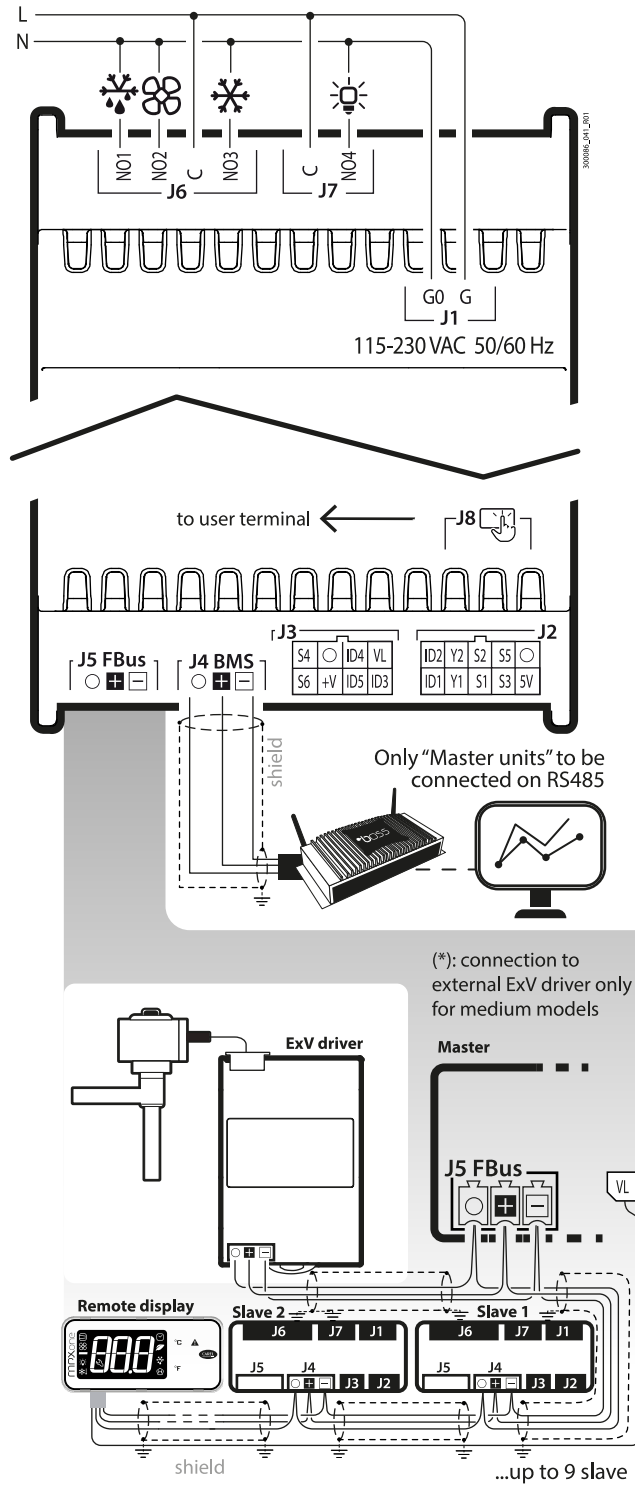

Fig.2.m

2.7 Positioning inside the panel

The position of the controller in the electrical cabinet must be chosen so as to guarantee correct physical separation from the power components (solenoids, contactors, actuators, inverters, ...) and the connected cables. Proximity to such devices/cables may create random malfunctions that are not immediately evident. The structure of the panel must allow the correct flow of cooling air.

2.8 Electrical installation

⚠ Important:

When laying the wiring, "physically" separate the power part from the control part. The proximity of these two sets of wires will, in most cases, cause problems of induced disturbance or, over time, malfunctions or damage to the components. The ideal solution is to house these two circuits in two separate cabinets. Sometimes this is not possible, and therefore the power part and the control part must be installed in two separate areas inside the same panel. For the control signals, it is recommended to use shielded cables with twisted wires. If the control cables have to cross over the power cables, the intersections must be as near as possible to 90 degrees, always avoiding running the control cables parallel to the power cables.

Pay attention to the following warnings:

- use cable ends suitable for the corresponding terminals. Loosen each screw and insert the cable ends, then tighten the screws. When the operation is completed, slightly tug the cables to check they are sufficiently tight;
- separate as much as possible the probe signal, digital input and serial line cables from the cables carrying inductive loads and power cables to avoid possible electromagnetic disturbance. Never run power cables (including the electrical cables) and probe signal cables in the same conduits. Do not install the probe cables in the immediate vicinity of power devices (contactors, circuit breakers or similar);
- reduce the path of the probe cables as much as possible, and avoid spiral paths that enclose power devices;
- avoid touching or nearly touching the electronic components fitted on the boards to avoid electrostatic discharges (extremely damaging) from the operator to the components;
- do not secure the cables to the terminals by pressing the screwdriver with excessive force, to avoid damaging the controller: maximum tightening torque 0.22-0.25 N·m;
- for applications subject to considerable vibrations (1.5 mm pk-pk 10/55 Hz), secure the cables connected to the controller around 3 cm from the connectors using clamps;
- all the extra low voltage connections (analogue and digital inputs, analogue outputs, serial bus connections, power supplies) must have reinforced or double insulation from the mains network.

2.9 Serial port connections

For serial connections (FBus and BMS ports), the cables used must be suitable for the RS485 standard (shielded twisted pair, see the specifications in the following table). The earth connection of the shield must be made using the shortest connection possible on the metal plate at the bottom of the electrical panel.

Master device	Serial port	Lmax (m)	Wire/wire capacitance (pF/m)	Resistance on first and last device	Max no. of slave devices on bus	Data rate (bit/s)
MPXone	FBus	10	<90	120 Ω	9	19200
PC (supervision)	BMS	500	<90	120 Ω	-	19200

The power supply connections must be in phase between the two controllers (G0 on the master controller and G0 on the slave controller connected to the same power supply wire); the serial connection between the two controllers (J5 FBus on the master and J4 BMS on the slave) must be made as shown in the following figures (+ with + and - with -).

- ➔ **Note:** connect the shield to the earth in the electrical panel. Use shielded twisted pair cable (e.g. Belden 8762 - AWG 20 or BELDEN 8761 - AWG 22). Connect a 120 Ω terminating resistor between the Tx/Rx+ and Tx/Rx- terminals on the last controller on the RS485 line.

Master/Slave Network

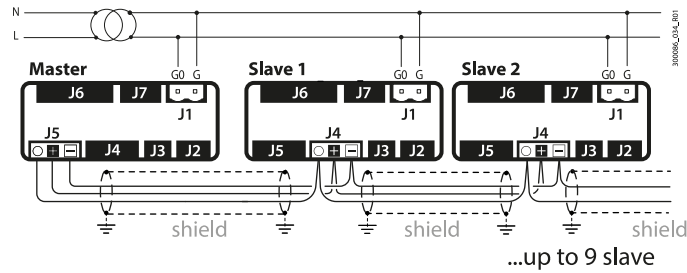

Fig.2.n

Master/Slave network and valve driver

⚠ Important: only the Medium models manage the external electronic valve driver.

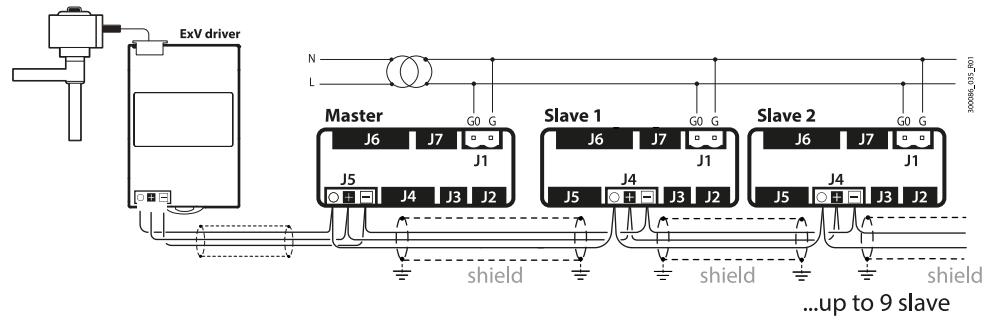

Fig.2.o

2.10 Functional diagrams

MPXone can control multiple refrigeration units (for example, one or more multiplexed showcases). These systems are made up of stand-alone controllers, or controllers that are connected to each other in a Master/Slave arrangement in which each Master controller can manage up to nine Slave controllers. The following functional diagrams illustrate some typical applications:

Stand-alone configuration.

🔍 Note: the user terminal is built-in on the panel version, and purchased separately for the DIN rail version. The remote display is optional for both the panel version and the DIN rail version.

Panel

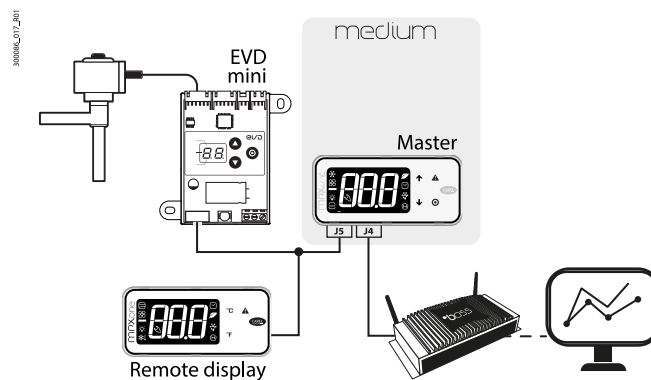

Fig.2.p

DIN

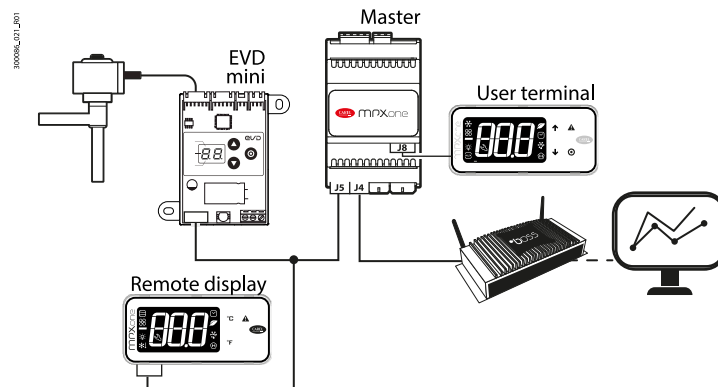

Fig.2.q

Master/Slave network with user terminals, remote display and external driver.

The Master controller, connected to the supervisor network, coordinates the operation of up to 9 Slave controllers connected to the network via RS485 Fieldbus. Each controller can be connected to a remote display or an external driver.

Panel

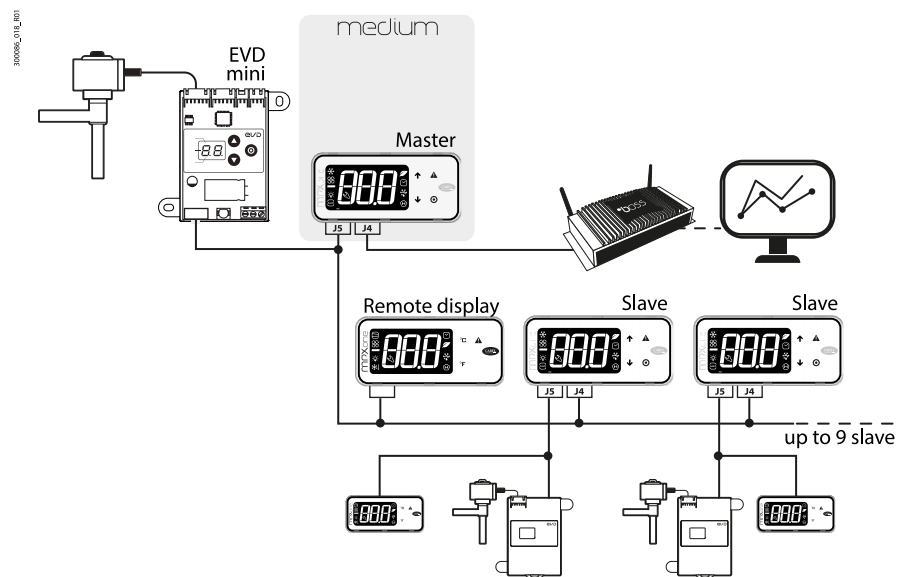

Fig.2.r

DIN

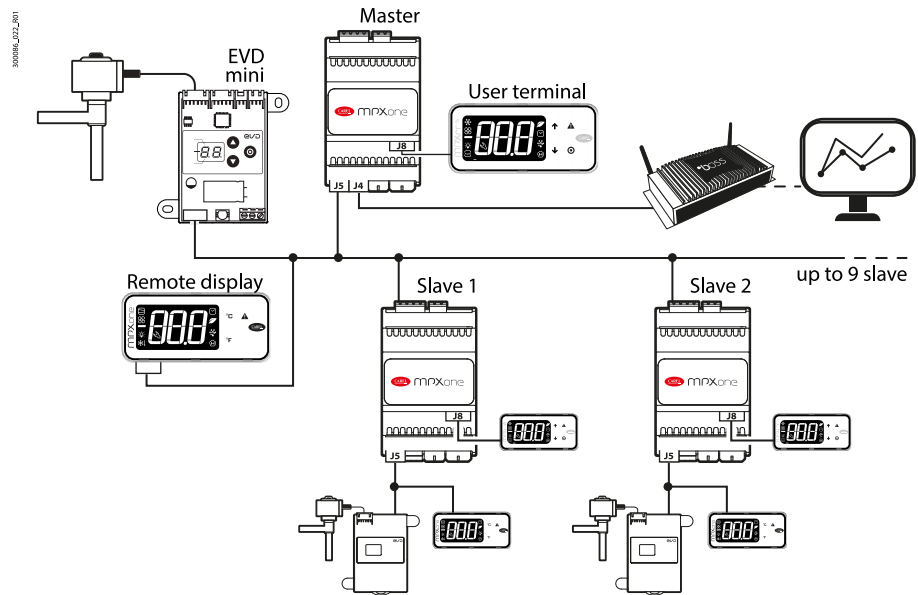

Fig.2.s

RS485 supervisor network

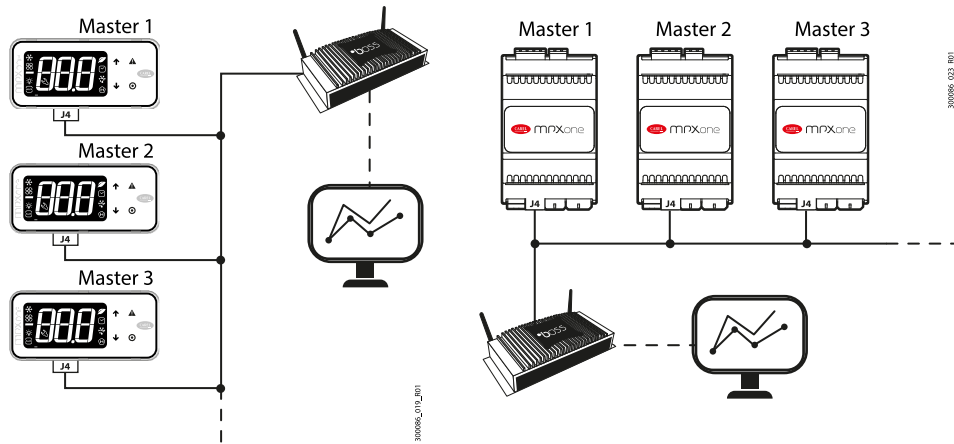

Fig.2.t

Fig.2.u

2.11 Installation

For installation proceed as follows, with reference to the wiring diagrams:

- before performing any operations on the control board, disconnect the main power supply by turning the main switch in the electrical panel OFF;
- avoid touching the control board, as electrostatic discharges may damage the electronic components;
- the index of protection required for the application must be ensured by the manufacturer of the cabinet or by suitable assembly of the controller;
- connect any digital inputs, $L_{max} = 10\text{ m}$;
- connect the actuators: the actuators should only be connected after having programmed the controller. Carefully evaluate the maximum ratings of the relay outputs as indicated in "Controller electrical and physical specifications";
- program the controller: see "User interface";
- for the connection of the Master/Slave network and user interfaces, use shielded cable and check the maximum distances and cable sizes specified in "Electrical specifications"
- for the safety devices (e.g. circuit breakers), refer to the following standards:
 - IEC 60364-4-41;
 - regulations in force in the country in question;
 - connection technical requirements of the power company.

⚠ Important: the following warnings must be observed when connecting the controllers:

- incorrect connection to the power supply may seriously damage the controller;
- use cable ends suitable for the corresponding terminals. Loosen each screw and insert the cable ends, then tighten the screws and lightly tug the cables to check correct tightness;
- separate as much as possible the probe and digital input cables from cables to inductive loads and power cables, so as to avoid possible electromagnetic disturbance. Never run power cables (including the electrical panel cables) and probe signal cables in the same conduits;
- do not install the probe cables in the immediate vicinity of power devices (contactors, circuit breakers, etc.); reduce the path of probe cables as much as possible, and avoid spiral paths that enclose power devices.

2.12 SPARK: configuration and commissioning software

SPARK is the configuration software, available for laptops, specifically designed to meet the needs of manufacturers and installers of multiplexed cabinets. The software is used to:

- configure access and password levels;
- change parameter sets and create custom read/write lists to upload to the device;
- add languages and parameter descriptions;
- view the trends of physical quantities in real time, with the possibility to save data in Excel format.

For the electrical connection, use the USB/RS485 converter CVSTDUMOR0.

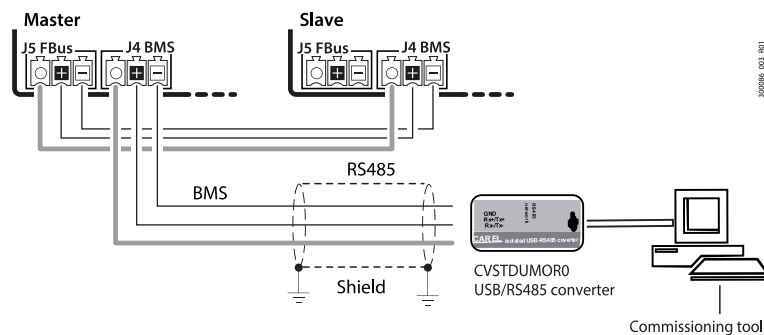

Fig.2.v

2.13 Setting the default parameters/loading the parameter sets

Two different sets of parameters are saved in the MPXone memory. These default sets can never be overwritten, being stored in a non-modifiable memory area. When resetting the system using the configuration wizard, one of the two configurations can be selected. The parameter set, differentiated by the user to control the specific refrigeration system, can be saved and uploaded to the linked cloud account using the Applica app.

Procedure for setting the default parameters/loading the parameter set

Set 0, called the working set, contains the set of parameters used by MPXone during normal operation. This set is loaded whenever MPXone is started, and the parameters can be modified at any time from the terminal, supervisor, APPLICA app and configuration software.

The other two sets of parameters, numbered 1 and 2, contain other lists of parameters, preloaded by CAREL during production, which can be copied as desired to the working set (Set 0). These sets of parameters, unlike Set 0, can only be modified using the appropriate configuration software. The sets of parameters, once differentiated by the manufacturer of the unit, can be loaded so as to rapidly set a list of parameters, with corresponding values, to control the refrigeration system.

User interface

Procedure:

1. power down the controller;
2. press PRG;
3. power up the controller again while holding PRG: at the end, the number 0 is displayed, which signifies the parameters have been reset to the default values;
4. to reset the parameters to the default values, press PRG and select 0, otherwise go to step 5;
5. press UP/DOWN to choose the set of parameters (1 or 2) to be loaded as the working set, and confirm by pressing PRG;
6. complete (if required) the commissioning procedure (see "Commissioning")

Applica

Procedure:

1. open Applica on the smartphone;
2. access the controller via NFC or Bluetooth, entering your profile credentials;
3. follow the path "Configurations/Configuration list";
4. select the "Default" or "Custom" label;
5. confirm the configuration to be opened (if connected to the controller via NFC, select Upload at the top right and move the smartphone closer to MPXone, while via Bluetooth the update will be completed automatically).

2.14 Applica: copy configuration

To simplify operations in the field, Applica includes a "Clone" feature to acquire the configuration from one unit and replicate it "one-for-one" to other cabinets.

Procedure:

1. open Applica on the smartphone;
2. access the controller via NFC or Bluetooth, entering the profile credentials;
3. follow the path "Configurations/Clone";
4. move the smartphone closer to the MPXone to acquire the configuration from;
5. following the acknowledgement message, move the smartphone closer to the MPXone to apply the same configuration to;
6. wait for the cloning confirmation message to be shown.

2.15 Applica: date/time and time bands

It is possible to set smartphone's date and time on the controller, via the drop-down menu on the side, selecting "set date/time".

To set the day/night time bands:

Procedure:

1. open Applica on the smartphone;
2. access the controller via NFC or Bluetooth, entering your profile credentials;
3. open the "Scheduler" section;
4. define the day/night time bands for the different days of the week;
5. apply the set schedule to the controller (upload button at the top-right for connection via NFC).

➔ **Note:** 8 daily time bands can be configured by setting parameters tS1, tE1 to tS8, tE8.

3. User interface

3.1 Introduction

The front panel of the user terminal includes the display and the keypad, featuring four buttons that, pressed alone or in combination, are used to program some functions of the controller. The remote display is only used to show the values of a selected system variable and any alarms. The user interface display features three digits with sign and decimal point, a buzzer for signalling alarms and nine icons. The terminal features wireless connectivity and an NFC (Near Field Communication) or Bluetooth interface for interaction with mobile devices (on which the CAREL "Applica" app has been installed, available on Google Play for the Android operating system).

Note :

- the password for accessing the user terminal parameters is 33, and is different from the password for accessing the user levels (U = User, S = Assistance, M = Manufacturer) on the APPLICA app. See the parameter table.
- the unit of measure of the displayed values can be changed by setting parameter /5.

Code	Description	Def	Min	Max	UOM	User	User terminal
/5	Unit of measure 0/1 = °C/barg/°F/psig	0	0	1	-	S	NO
PDM	Manufacturer password	44	0	99	-	M	NO
PDS	Service password	22	0	99	-	M	NO
PDU	User password	-	0	99	-	S	NO

The buzzer and the keypad can be disabled by setting parameters H8 and H5 respectively.

Code	Description	Def	Min	Max	UOM	User	User terminal
H5	Enable keypad and NFC functions 0/1 = Disabled/Enabled	1	0	1	-	U	NO
H8	Buzzer 0/1 = No/Yes	1	0	1	-	U	NO

The information available on the user terminal and in the Applica app may vary according to the type of profile, the password entered and the configuration parameters set by the manufacturer. See the parameter table.



3.2 User terminal and remote display

The display shows measurements in the range -50 and +150°C, according to the type of probe used. For 0 to 5 V ratiometric and active 0 to 10 V or 4 to 20 mA probes the unit of measure is defined by the type of probe used. The decimal point can be disabled by setting a parameter (/6).

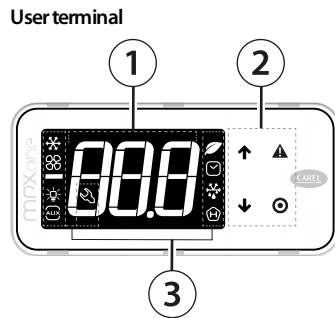

Fig.3.a

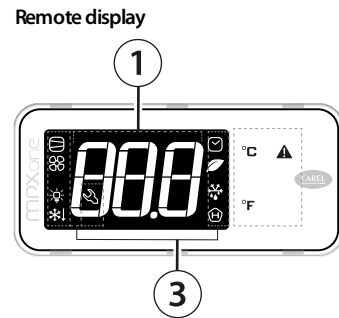

Fig.3.b





Ref.	Description
1	Main field
2	Keypad
3	Operating mode

Note:

- the user terminal can only be used to set the frequent parameters (St, rd, d0, dl) and display the value of the probes connected to MPXone. The Service- and Manufacturer-level parameters are set using the "Applica" app or the configuration software, depending on the access profile. See the parameter table.
- Parameters /t1 and /t2 are used to choose the variable shown on the display during normal operation, while /t enables display of the alarms on the remote display.

Code	Description	Def	Min	Max	UOM	User	User terminal
/6	Display decimal point 0/1 = Yes/No	0	0	1	-	S	NO
/t	Display signals/alarms on remote display 0/1 = Disabled/Enabled	0	0	1	-	S	NO
/t1	Display on user terminal 0 = Terminal disabled 1 to 6 = Probe 1 to 6 7, 8 = Reserved 9 = Control probe 10 = Virtual probe 11 to 14 = Serial Probe 1 to 4 15 = Temperature set point	12	0	18	-	S	NO
/t2	Display on remote display - see /t1	12	0	14	-	S	NO









3.2.1 Keypad

Keypad		
 UP	 DOWN	<ul style="list-style-type: none"> • Increase/decrease the value • Scroll direct access functions • LED on: scroll menu, parameters, direct access functions • LED flashing: set parameter values
 PRG		Pressed briefly: <ul style="list-style-type: none"> • Enter direct access function menu (from main screen) and activate/deactivate functions • Save value and return to the parameter code Pressed and held (3 s): <ul style="list-style-type: none"> • Enter programming mode or return to previous level without saving • LED on: main screen/programming mode
 ALARM		<ul style="list-style-type: none"> • Pressed briefly: display alarms and mute buzzer • Pressed and held (3s): reset alarms • LED on/flashing: acknowledged/active alarm

➔ **Note:** when scrolling, a button is enabled only when illuminated.

3.2.2 Display

The icons provide information on device operation and/or the activation of certain functions, as shown in the table.

Icon	Function	On	Flashing
	Solenoid/compressor	Solenoid/compressor active	Compressor timers active
	Evaporator fan	Evaporator fan on	-
	Lights	Light on	-
	Auxiliary output	Auxiliary output active	-
	Clock	Scheduler active	-
	Energy saving	Smooth Lines active	-
	Defrost	Defrost active	Awaiting defrost
	Service	Maintenance request	
	HACCP	HACCP active	-

Tab.3a

3.2.3 Standard display

At start-up, the user terminal briefly shows "NFC", indicating that the NFC interface is available for communication with mobile devices, then the Firmware version, and then the standard display is shown. The standard display depends on the setting of parameter /t1:

- control temperature (control probe temperature or calculated based on two probes, see chap. "Functions");
- value of one of the probes connected to the analogue inputs;
- control/virtual probe;
- temperature set point.

➔ **Note:** the message "bLE" flashes during the Bluetooth connection on the user terminal.

3.2.4 Programming mode

The user terminal only provides access to the basic configuration parameters, such as direct functions and active alarms without password protection, or, with password protection, unit set-up and optimisation. Pressing PRG on the main screen for 3 s accesses programming mode; see the menu descriptions for details of the available items.

Parameter categories visible on the user terminal

VIS (Display)	CtL (Control)	DEF (Defrost)	ALM (Alarms)	FAN (Fans)	EVD (Electronic exp. valve)	CnF (Configuration)
Sm	PPU	On	d0	AA	F0	P1
Sd	tGS	St	dl	A0	F1	P3
Sr	tEu	rd	dt1	AL	Frd	P7
Sa	PEu	ESC	dP1	AH	ESC	ESC
Sv	ESC	ESC	Ad			
Svt			ESC			

Procedure

To navigate the menu tree, use the following buttons:

- UP and DOWN to navigate the menu and set the values;
- PRG to enter the menu items and save the changes made;
- PRG (3s) to select the menu item or ESC to return to the previous branch.

Example of how to set parameter St (set point):



1. Wait for the standard display to be shown;



2. Press PRG for 3 s: the password prompt is displayed (PSd)



3. Press PRG: UP and DOWN flash



4. Press UP and enter the password: 33



5. Press PRG: the first category of parameters is displayed: VIS (=Display)



6. Press DOWN: the second category of parameters is displayed: Ctl (=Control)



7. Press DOWN until reaching parameter St (=set point) and PRG to display the value



8. Press UP/DOWN to modify the value



9. Press PRG to save the setting and return to the parameter code



10. Press PRG for 3 s or alternatively, in the parameter level select ESC and press PRG to return to the parameter categories



11. Press DOWN to move to the next category dEF (=Defrost) and follow steps 5 to 9 to set the other parameters



12. After having completed the settings, to exit either: a) from the categories press ESC and then PRG; or b) press PRG for 3 s

➔ **Note:** if no button is pressed, after around 1 minute the terminal will automatically return to the standard display.

Mobile device and PC

The Applica app and SPARK software can be used to configure the controller from a mobile device (smartphone, tablet), via NFC (Near Field Communication) or Bluetooth (in this case also by laptop). The controller can be programmed according to the profile used for access to APPLICA or SPARK, with

different parameter visibility depending on the rights associated with each profile (User, Service, Manufacturer).

Procedure:

1. download the “Applica” app for Android devices from Google Play;
2. (on the mobile device) start the app for commissioning the controller;
3. activate NFC;
4. move the device closer to the controller, less than 10 mm away;
5. follow the instructions shown on the display.

3.2.5 Direct functions

The following functions can be activated directly from the keypad or via the app:

Icon	Display	On/Off
	Lht	Cabinet light
	Cnt	Continuous cycle
	dEF	Defrost
	CLn	Clean cabinet
	ON	Unit ON
	rH	Anti-sweat heater

Procedure:

1. go to the standard display;
2. press PRG: Lht is displayed;
3. press PRG to turn the light on/off and DOWN to move to the next direct function;
4. follow the previous steps for all the other functions;
5. When finished, press Esc to exit.



1. Go to the standard display;



2. Press PRG: Lht is displayed, the UP and DOWN buttons light up. Press PRG to turn the light on/off: the icon will come on or go off. Press DOWN to activate the next function (Cnt) or press Esc to exit;



3. Press PRG to activate the continuous cycle (Cnt). Press DOWN to activate the next function;



4. Follow the previous steps for all the other functions;

5. Select Esc to exit;



6. The standard display is shown

4. Initial configuration

Once the electrical connections have been completed (see "Installation") and the power supply has been connected, the operations required for commissioning the controller depend on the type of interface used, however essentially involve setting the so-called initial configuration parameters.

The initial configuration procedure can be run on the user terminal or mobile device (with the APPLICA app).

The parameters used for initial commissioning are shown in the Commissioning parameter table.

⚠ Important: the parameters that can be set on the user terminal and in the APPLICA app may vary according to the rights assigned to the access profile, defined by the manufacturer. Therefore, not all of the following parameters may be visible or modifiable.

4.1 Wizard

MPXone features highly configurable inputs and outputs. CAREL in any case recommends a configuration following the default settings of the parameters. By following this suggestion, the controller can independently manage the main functions in most applications, without having to significantly modify the settings of the parameters.

4.1.1 User terminal

When first started, MPXone runs a procedure (configuration wizard) that requires the settings of the critical parameters, relating to:

- correct configuration of the probe types;
- correct communication of the controller with the supervisor and the Master/Slave network;
- management of the electronic valve, if featured.

➡ **Note:** the configuration wizard can also be:

- run via the "APPLICA" app
- skipped by creating a parameter configuration using the SPARK configuration software.

During this procedure, the device remains in standby and all of its functions are deactivated (including control and communication via RS485). The special configuration menu is only displayed on the user terminal, and therefore one needs to be connected if the function is not deactivated (avoiding conflicts in the network/LAN or refrigerant return to the compressor). Only after having set all of the required parameters will it be possible to continue with normal configuration.

4.2 APPLICA

The "APPLICA" app can be used to configure the controller from a mobile device (smartphone, tablet), via NFC (Near Field Communication) or Bluetooth.

Procedure (modify parameters):

- download the CAREL "Applica" app for Android devices from Google Play;
- (on the mobile device) enable NFC and/or Bluetooth communication and mobile data;
- open Applica;
- move the mobile device near to the user terminal, maximum distance 10 mm (for NFC only), so as to recognise the configuration;
- select the access profile and enter the required password (*);
- set the parameters as needed;
- move the mobile device near to the user terminal again to upload the configuration parameters.

(*) pre-assigned by the unit manufacturer to allow maintenance only by authorised service technicians. See the parameter table.

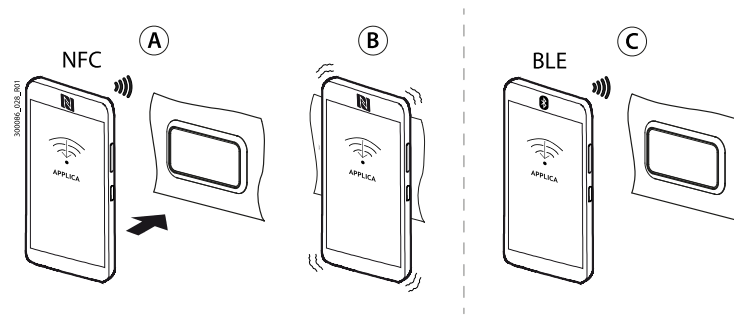

Fig.4.a

Commissioning parameters

Par.	Desc.	Model
In	Type of unit	Basic, Medium
Sn	Number of slaves in the local network (*)	Basic, Medium
H0	Serial or Master/Slave network address	Basic, Medium
H3	BMS serial port protocol	Basic, Medium
/P1	Type of probe, group 1 (S1, S2, S3)	Basic, Medium
P1	Electronic valve	Medium
PH	Refrigerant	Medium
/P2	Type of probe, group 2 (S4, S5)	Medium
/P3	Type of probe, group 3 (S6)	Medium
/Fd	Assign superheated gas temperature probe (tGS)	Medium
/FE	Assign saturated evaporation pressure/temperature probe (PEu/tEu)	Medium
/UE	Maximum value for saturated evaporation pressure probe (PEu/tEu)	Medium
/LE	Minimum value for saturated evaporation pressure probe (PEu/tEu)	Medium
End	Exit the initial configuration procedure	Basic, Medium

Tab.4.a

(*) not displayed if In = 0.

⚠ Important: at the end of the configuration wizard, the unit will be ON and the temperature set point = 50°C.

In: Type of unit

This parameter In assigns the function of Master or Slave to the controller.

4.3 Description of the initial configuration parameters

Code	Description	Def	Min	Max	UOM	User	User terminal
In	Type of unit 0/1 = Slave/Master	0	0	1	-	S	NO

Sn: Number of slaves in the local network

This parameter tells the Master controller how many Slave controllers it needs to manage in the local network. If Sn = 0, this is a stand-alone unit. The maximum number of Slave controllers in a subnet is 9. On Slave controllers, the parameter must be left at 0.

Code	Description	Def	Min	Max	UOM	User	User terminal
Sn	No. of slaves in the local network 0 = no Slaves	0	0	9	-	S	NO

H0: Serial or Master/Slave network address

On a Master controller this represents the address of the controller in the CAREL or Modbus supervisor network.

The address of Slave controllers must comply with the following rule (see the example):

$$H0_{slave} = H0_{master} + n$$

$$n = 1 \dots 9$$

Code	Description	Def	Min	Max	UOM	User	User terminal
H0	Serial or Master Slave network address	199	0	199	-	S	YES

⚠ Important: if multiple Masters, with their own local networks, are connected to a supervisor network, the address set for each Master must consider the number of Slaves in the previous network.

➡ Note: only the Master controller needs to be connected to the RS485 serial line (connector J4 BMS), all of the Slave controllers communicate with the supervisor via the Master, connected to the master's RS485 Fieldbus port (connector J5 FBus). See "Functional diagrams".

Example

The addresses must be configured for a supervisor network comprising three Master controllers, which respectively manage 5, 3 and 1 Slave controllers.

Solution

For example, assign to the three Master controllers the addresses H0 = 200, 210, 220 respectively, which also represent the controller address in the supervisor network. See the figure below for the addresses to be assigned to the Slave controllers.

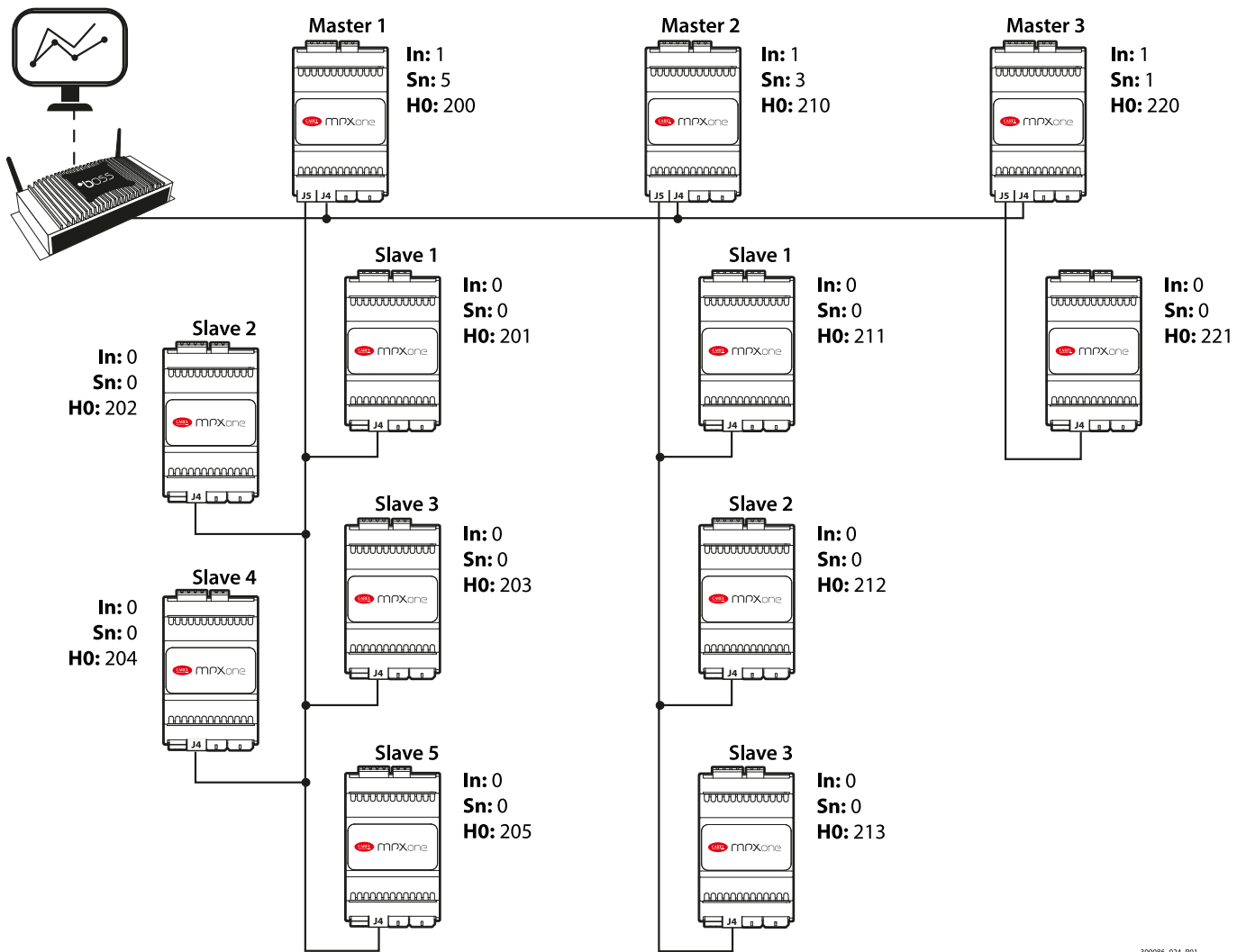

Fig.4.b

300086_024_R01

Note: MPXone is compatible with Carel and Modbus® supervisor networks. The type of protocol is set via parameter H3

H3: BMS serial protocol

MPXone is compatible with Carel and Modbus supervisor networks, which can be selected using parameter H3.

Code	Description	Def	Min	Max	UOM	User	User terminal
H3	BMS serial port protocol 0/1 = Carel slave/Modbus slave	1	0	1	-	S	NO

/P1: Type of probe, group 1 (S1, S2, S3)

This is used to select the type of temperature probe to be used for inputs S1, S2 and S3.

Code	Description	Def	Min	Max	UOM	User	User terminal
/P1	Type of probe, group 1 (S1, S2, S3) 0 = PT1000 Standard Range -50T150 °C 1 = NTC Standard Range -50T90°C	1	0	1	-	S	NO

P1: Type of electronic expansion valve

Code	Description	Def	Min	Max	UOM	User	User terminal
P1	Electronic valve type 0 = not used/thermostatic valve 1 = reserved 2 = CAREL E2V valve (suction temp. probe connected) 3, 4, 5 = reserved 6 = CAREL E2V valve (suction temp. probe on external driver)	0	0	6	-	S	YES

PH: Type of refrigerant

The type of refrigerant is essential for calculating the superheat value. In addition, it is used to calculate the evaporation and condensing temperature based on the pressure probe reading. The table of predefined refrigerants is shown below.

Code	Description	Def	Min	Max	UOM	User	User terminal
PH	Refrigerant	3	0	40	-	S	NO
	Val. Desc. Val. Desc. Val. Desc.						
	0 Custom gas 14 R417A 28 HFO1234ze						
	1 R22 15 R422D 29 R455A						
	2 R134a 16 R413A 30 R170						
	3 R404A 17 R422A 31 R442A						
	4 R407C 18 R423A 32 R447A						
	5 R410A 19 R407A 33 R448A						
	6 R507A 20 R427A 34 R449A						
	7 R290 21 R245Fa 35 R450A						
	8 R600 22 R407F 36 R452A						
	9 R600a 23 R32 37 R508B						
	10 R717 24 HTR01 38 R452B						
	11 R744 25 HTR02 39 R513A						
12 R728 26 R23 40 R454B							
13 R1270 27 HFO1234yf							

/P2: Type of probe, group 2 (S4, S5)

This is used to select the type of probe to be used for inputs S4 and S5.

Code	Description	Def	Min	Max	UOM	User	User terminal
/P2	Type of probe, group 2 (S4, S5) 1 = NTC Standard Range -50T90°C 2 = 0-5 V 3 = 4-20 mA	2	1	3	-	S	NO

/P3: Type of probe, group 3 (S6)

This is used to assign the type of probe connected to input S6.

Code	Description	Def	Min	Max	UOM	User	User terminal
/P3	Type of probe, group 3 (S6) 0 = PT1000 Standard Range -50T150 °C 1 = NTC Standard Range -50T90°C 2 = 0-5 V 3 = 4-20mA 4 = 0-10V	2	0	4	-	S	NO

/Fd: Assign tGS (superheated gas temperature probe)

This is used to assign the measurement of the superheated gas temperature at the evaporator outlet to the selected probe.

Code	Description	Def	Min	Max	UOM	User	User terminal
/Fd	Assign superheated gas temperature probe (tGS) - see /FA	0	-4	6	-	S	NO

/FE: Assign PEu/tEu (saturated evaporation pressure/temperature probe)

This is used to assign the measurement of the saturated evaporation pressure/temperature to the selected probe. It is recommended to connect the 0-5 Vdc ratiometric probe input S6.

Code	Description	Def	Min	Max	UOM	User	User terminal
/FE	Assign saturated evaporation pressure/temperature probe (PEu/tEu) - see /FA	0	-4	6	-	S	NO

/UE, /LE: Maximum/minimum value of probe PEu

Parameters /UE and /LE are used to adapt the maximum and minimum limits of the PEu probe's range of measurement.

Code	Description	Def	Min	Max	UOM	User	User terminal
/UE	Maximum value for saturated evap. pressure/temp. probe (PEu/tEu)	9.3	/LE	200	°C/°F	M	NO
/LE	Minimum value for saturated evap. pressure/temp. probe (PEu/tEu)	0	-1	/UE	°C/°F	M	NO

4.4 Checks after commissioning

Once having completed the installation, configuration and programming operations, after commissioning the controller check that:

- the programming logic is suitable to control the unit and the system in question;
- the day/night time bands have been set correctly;
- the standard display has been set on the user terminal and remote display;
- the appropriate unit of measure has been set for the temperature probes (°C or °F);
- the label on the cover of each controller shows:
 - serial address;
 - Master or Slave
 - the number of Slaves;
 - any notes.

⚠ Important: the alarm log can be reset via the APPLICA app. See "Alarms".

5. Functions

If the settings made during commissioning are not sufficient to achieve the desired operation, further (detailed) configuration of the parameters can be performed, as described in the following paragraphs.

The parameters described below can be configured via the configuration software or the "APPLICA" app.

⚠ Important: the information available in Applica may vary according to the password set and the configuration set by the unit manufacturer, and consequently not all the parameters shown may be visible or modifiable.

For details on the parameters and the related access levels, see the "Parameter table".

5.1 Inputs and outputs

MPXone features up to 6 analogue inputs and 5 digital inputs. See the description of the terminals in the paragraph "Description of the terminals".

The probes (temperature NTC, PT1000, 0-5 Vdc ratiometric and active probes), can be connected to the analogue inputs, and have been divided into 3 groups, with the same type of probe for each group. See the parameter table.

Model	Part number	Probes					Outputs (Y1, Y2)	
		Passive		Active			PWM	0 to 10 Vdc
		NTC (-50T90°C)	Pt1000 (-50T150°C)	0 to 5 V ratiometric	4 to 20 mA	0 to 10 V active probes		
BASIC	S1M0004W0B06 (0/1)	YES	NO	NO	NO	NO	NO	NO
MEDIUM	S1M0006W0B07 (0/1)	YES	YES	YES	YES	YES	YES	YES
	S1M0006B0B08 (0/1)	YES	YES	YES	YES	YES	YES	YES
	S1M0007N0B11 (0/1)	YES	YES	YES	YES	YES	YES	YES

⚠ Important: observe the maximum allowable current limits on the relays. See the technical specifications table.

5.1.1 Probes (analogue inputs)

MPXone version	Basic			Medium					
	S1	S2	S3	S1	S2	S3	S4	S5	S6
Analogue input									
Parameter for type of probe	/P1			/P1			/P2		/P3
0 = PT1000 Standard (Range -50T150 °C)				●	●	●			●
1 = NTC Standard (Range -50T90 °C)	●	●	●	●	●	●	●	●	●
2 = 0-5V ratiometric probe							●	●	●
3 = 4-20 mA input							●	●	●
4 = 0-10V input									●

⚠ Important: for the maximum current that can be supplied to the ratiometric probes, see the technical specifications table

Inputs S4, S5 and S6 can be connected to 0-5 V ratiometric pressure probes and active probes with 4-20 mA or 0-10 V output (S6 only). All these probes require the range of measurement to be defined, set by the relative minimum and maximum parameters for the function associated with the probe. See the parameter table.

To assign the function to each physical or serial probe, configure parameters /FA, /Fb, ... /Fn. See the parameter table.

Probe	Par.	Probe	Par.
Air off (Sm)	/FA	Auxiliary temperature 1 (Saux 1)	/FG
Defrost (Sd)	/Fb	Auxiliary temperature 2 (Saux 2)	/FH
Air on (Sr)	/Fc	Ambient temperature	/FI
Superheated gas temperature (tGS)	/Fd	Ambient humidity	/FL
Saturated evaporation pressure/temperature (PEu/tEu)	/FE	Glass temperature	/FM
Defrost probe 2 (Sd2)	/FF	Dewpoint	/Fn

MPXone can adjust the values read by the probes. In particular /cA, /cb.../cn are used to increase or decrease the physical values read by the probes. Parameter /co, on the other hand, corrects the value of the saturated evaporation temperature calculated directly based on the evaporation pressure. The serial probes can be calibrated, while the probes shared with the Master (such as the pressure probe) are calibrated by the Master.

⚠ Important: HACCP: this modification may not be allowed by HACCP procedures as it alters the measured value. Verify that you have authorisation and record the changes where required.

Shared probe

One single pressure probe can be shared across the Master-Slave network; this must be connected to the Master. Simply configure the probe correctly using parameters /FE, /UE, /LE and on the Slaves set /FE = 0 (function disabled). In this way, the Slaves automatically search for the pressure value shared by the Master and used for calculating the local superheat. This is used to save on the installation costs of a pressure probe for each evaporator, assuming that the pressure drop in that section of the line is negligible.

Probe positioning and part numbers

See "Introduction" for the probe part numbers.

➔ Note:

- the glass probe must be connected to the coldest point of the cabinet door, so as to ensure the anti-sweat device (heater or fans) works most efficiently. See the technical leaflet +050002005;
- for more information see the technical leaflets, downloadable, even prior to purchase, from the site www.carel.com

The temperature and humidity probes must be positioned not too far from the cabinets being monitored. At times it is better to install more than one if the supermarket is divided into sections with greatly differing temperature and humidity values (frozen section, meat section, fruit and vegetable section, etc.)

Assign probe functions (parameters /FA, /Fb, /Fc)

Code	Description	Def	Min	Max	UOM	User	User terminal
/FA	Assign air off temp. probe (Sm) 0 = Function disabled 6 = Probe S6	1	-4	6	-	S	NO
	1 = Probe S1 -1 = Serial probe S11						
	2 = Probe S2 -2 = Serial probe S12						
	3 = Probe S3 -3 = Serial probe S13						
	4 = Probe S4 -4 = Serial probe S14						
	5 = Probe S5						
/Fb	Assign defrost temperature probe (Sd) - see /FA	2	-4	6	-	S	NO
/Fc	Assign air on temperature probe (Sr) - see /FA	3	-4	6	-	S	NO

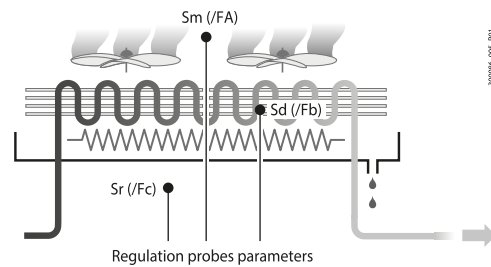
Fig.5.a

MPXone, inside the showcase or cold room, can use temperature probes to measure:

- the air outlet (off) temperature (at the evaporator outlet);
- the defrost temperature (in contact with the coldest point of the evaporator);
- the air return (on) temperature (at the evaporator inlet).

The default configuration for assigning the control probes is as follows:

- S1 = Air off probe (Sm);
- S2 = Defrost probe (Sd);
- S3 = Air on probe (Sr).

The default configuration also involves these three probes being standard CAREL NTC. However, other types of probes can be connected by setting parameter /P1. On MPXone the default settings can be changed to choose the function associated with any of the probes connected. There are also cases where the characteristics of the applications require different settings.

Share control status

This function is used to satisfy the needs of cold rooms or showcases with multiple evaporators, where the Slaves are essentially used as expansions for the management of different electronic valves. This function shares the Master control status across the LAN (RS485). In this way, the Master determines the control status, and each Slave operates as a consequence, without consider the parameters set locally. This means Slave controllers can be used without the air off and on probes. If the Slave controller is not accessible from the Master, "duty setting" operating mode must be activated, setting the corresponding parameter c4 >0.

Activation: to activate sharing of the control status, set /FA = 0 and /Fc = 0 on the MPXone Slave controllers.

➔ Note:

- the configuration /FA = 0 and /Fc = 0 on a Master controller causes the alarm 'rE' (control probe alarm)
- if the Slave controller is not accessible from the Master, alarm 'MA' is displayed (Communication error with the Master - only on the Slave)

The function manages the control status (activation and deactivation of the cooling request) on the Slave controllers from the Master via the LAN (RS485). This means that only the Master parameters (set point, differential, night-time set point variation, control offset in the event of probe error) affect the control algorithm. The value of the same parameters on the Slaves has absolutely no influence. If the Slave controller is not accessible from the Master (the user interface shows alarm 'MA'), "duty setting" mode is activated based on the local setting of parameter c4, and the corresponding management (duty setting starts in the status found prior to the instant it is activated, i.e. it starts with compressor on if this was on, and with compressor off if it was off).

➔ Notes:

- if the Master controller enters duty setting mode, the related Slave controllers follow as regards the compressor management times and the user interface does not show the icon flashing when the compressor is off, due to the fact that they ignore the Master control mode. On the other hand, if the Slaves enter duty setting mode due to lack of communication with the Master; in this case they manage the user interface correctly;
- activation of the continuous cycle on the Master means all the dependent Slaves observe the compressor management times on the Master (parameter cc on the Master only will take effect, while the settings on the Slaves will be ignored). This operating mode is only highlighted on the

Master user terminal, as the Slave controllers ignore the Master control mode. This means that a Slave controller serving the Master, even in the continuous cycle, manages the user interface as if it were in normal control (solenoid/compressor icon on during cooling request and off when no request). Attempts to activate continuous cycle on a Slave serving the Master are ignored, both local and sent from the Master.

Calibration (parameters /cA, ... /co)

MPXone can calibrate the values read by the probes associated with the various functions set by parameters /FA, ... /Fn, as well as internal variables. In particular, /cA, .../cn, /cc are used to increase or decrease the values read by the probes connected to the analogue inputs across the range of measurement. Parameter /cE, on the other hand, corrects the value of the saturated evaporation temperature calculated directly based on the evaporation pressure.

⚠ Important: HACCP: this modification may not be allowed by HACCP procedures as it alters the measured value. Verify that you have authorisation and record the changes where required.

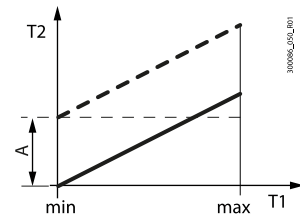

Fig.5.b

Ref.	Description
T1	Outlet temperature read by the probe
T2	Outlet temperature (value calibrated by T1)
A	Offset
min, max	Field of measurement

Code	Description	Def	Min	Max	UOM	User	User terminal
/cA	Air off temp. probe (Sm) calibration	0	-20	20	°C/°F	S	NO
/cb	Defrost temp. probe (Sd) calibration	0	-20	20	°C/°F	S	NO
/cc	Air on temp. probe (Sr) calibration	0	-20	20	°C/°F	S	NO

⚠ HACCP, important: modifying the parameters that influence temperature measurement and display may not be allowed in certain applications (e.g.: HACCP).

/2: Analogue probe measurement stability

Code	Description	Def	Min	Max	UOM	User	User terminal
/2	Analogue probe measurement stability	4	1	15	-	M	NO

Defines the coefficient used to stabilise the temperature measurement. Low values assigned to this parameter allow a prompt response of the sensor to temperature variations; the reading however become more sensitive to disturbance. High values slow down the response, but guarantee greater immunity to disturbance, that is, a more stable, precise and filtered reading.

5.1.2 Digital inputs

MPXone manages up to 5 physical digital inputs and 1 virtual digital input. See "Installation".

To associate a physical or virtual input to each available function, set parameters DIA, DIb, ... Dlr parameters to the value relating to the physical or virtual digital input. See the parameter table.

Digital input functions

Digital input assignment for:	Par.	Contact	
		Open	Closed
immediate external alarm	DIA	Active	Not active
delayed external alarm	DIb	Active	Not active
enable defrost	DIc	Not enabled	Enabled
start defrost	DI d	Not active	Active
door switch with stopping control	DI E	Door open	Door closed
remote ON/OFF	DI F	OFF	ON
curtain switch/light	DI G	Day status	Night status
start/stop continuous cycle	DI H	Not active	Active
digital input monitoring	DI I	Active	Not active
timed digital input	DI L	Active	Not active
switch to Standby status	DI M	Active	Not active
switch to Clean status	DI n	Active	Not active
change working set	DI o	Set 1	Set 2
door switch without stopping control	DI p	Door open	Door closed
defrost corresponding to digital input status	DI r	Not active	Active

If the opposite logic to the default setting is required, or to correct a wiring error, the logic of the functions associated with the digital inputs using parameters rIA, rIb, ... rIr can be reversed.

Par.	Description	Def.	UOM	Min	Max
rIA, rIb, ... rIr	Reverse digital input logic	0	-	0	1

Note: reversing the logic has no effect on the virtual DI

The virtual digital input is a function by which the status of a digital input is broadcast via LAN (RS485) from Master to Slave. This is useful, for example, when using a switch to change from day to night status and vice-versa without extra wiring from the Master to the Slaves. The virtual digital input can be set by the supervisor or by the Master, according to the setting of parameter A9 (set only on the Master).

Code	Description	Def	Min	Max	UOM	User	User terminal	
A9	Select digital input broadcast from Master to Slaves (only on Master)	0	0	5	-	S	NO	
	0 = from supervisor							3 = Digital input 3 (ID3)
	1 = Digital input 1 (ID1)							4 = Digital input 4 (ID4)
	2 = Digital input 2 (ID2)							5 = Digital input 5 (ID5)

Setting parameters DIA, DIb, ... Dlr to -1 allows the virtual digital input to be selected on the Slave as an input. If needed, different functions can be configured on the Slaves, meaning when the status of the contact on the Master changes, different functions are activated on the Slaves.

Par.	Description	Def.	UOM	Min	Max
DIA, DIb, ... Dlr	Assign digital input function ... - 1: serial digital input	0	-	-1	5

Immediate external alarm (par. DIA)

Activation of the alarm causes:

- message 'IA' shown on the display and ALARM flashing;
- activation of the buzzer (see par. H8);
- activation of the alarm relay (see par. DOb);
- deactivation of the solenoid/compressor output (see par. A10).

➔ **Note:** activation of the external alarm shuts down the evaporator fans only if these follow the status of the compressor output, as set for parameter F2. When the compressor is shut down due to an external alarm the compressor ON time is ignored (parameter c3).

Code	Description	Def	Min	Max	UOM	User	User terminal
DIA	Assign immediate external alarm digital input 0 = Function disabled	0	-1	5	-	S	NO
	4 = digital input 4 (ID4)						
	1 = digital input 1 (ID1)						
	2 = digital input 2 (ID2)						
	3 = digital input 3 (ID3)						
	5 = digital input 5 (ID5)						
	-1 = digital input serial						

Delayed external alarm (par. DIb)

The behaviour of this alarm is the same as for the immediate external alarm, with a delay in activation. If set to 0, the alarm is signal-only.

Code	Description	Def	Min	Max	UOM	User	User terminal
DIb	Assign delayed external alarm digital input - see DIA	0	-1	5	-	S	NO
A11	Delay time for delayed external alarm 0 = Signal-only alarm	0	0	14	-	S	NO

Enable defrost (par. DIc)

Used to disable any defrost calls. When the contact is open, all defrost calls are ignored. Par. d5 can be used to delay activation.

➔ **Note:**

- if the contact is open while a defrost is in progress, this is immediately stopped, the defrost icon flashes on the display indicating the defrost call is active (this starts again when the contact closes);
- this function may be useful to prevent defrosts on units exposed to the public during store opening hours.

Code	Description	Def	Min	Max	UOM	User	User terminal
DIc	Assign enable defrost digital input - see DIA	0	-1	5	-	S	NO

Start defrost (par. DId)

Closing the digital contact starts a defrost, if enabled. With a Master-Slave network connection, if the controller is the Master, the defrost will be a network defrost, while if it is a Slave, it will only be a local defrost. The defrost digital input can be used effectively to perform real time defrosts. Simply connect a timer to the multifunction digital input on the Master and use d5 to delay the defrosts on the various Slaves and thus avoid current overloads.

➔ **Note:** if the defrost is disabled by another digital input configured as "enable defrost", the defrost calls are ignored.

Code	Description	Def	Min	Max	UOM	User	User terminal
DId	Assign start defrost digital input - see DIA	0	-1	5	-	S	NO
d5	Defrost delay on power-up or (for Slave) after control from	0	0	240	min	S	NO

Code	Description	Def	Min	Max	UOM	User	User terminal
	Master 0 = delay disabled						

Door switch with stopping control (par. DIE)

Door open:

- stop control (solenoid/compressor and evaporator fans off); alternatively, control can be kept active by setting parameter DIP (see the description below);
- light on (see par. DOE);
- ALARM flashing;
- disable temperature alarms.

Door closed:

- resume control;
- light off (see par. DOE) with delay set by par. H14;
- ALARM stops flashing;
- enable temperature alarms with delay Ad after bypass time defined by par. Add.

Code	Description	Def	Min	Max	UOM	User	User terminal
DIE	Assign door switch with solenoid/comp. and evap. fans OFF digital input - see DIA	0	-1	5	-	S	NO
DOE	Assign light digital output - see DOA	4	0	4	-	S	NO
H14	Time light stays on after closing the door	0	0	240	min	U	NO
Ad	Delay time for high and low temp. alarms (AH, AL)	120	0	240	min	U	YES
Add	High temp. alarm bypass time for door open	30	1	240	min	U	NO

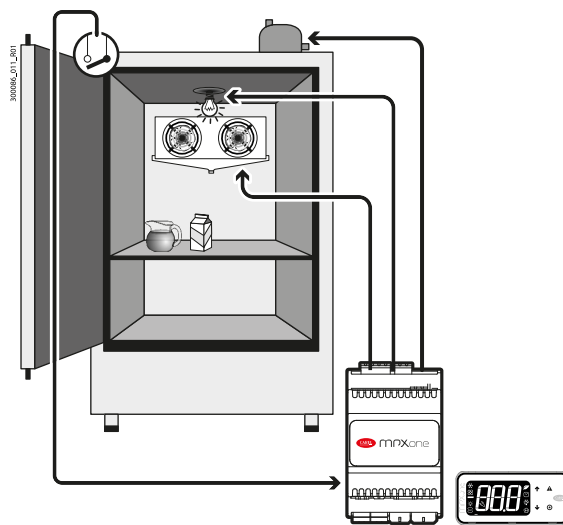

Fig.5.c

⚠ Important: check compatibility of disabling/delaying the alarm with the site’s HACCP procedures.

📌 Note:

- when control resumes, the compressor times are observed (see the paragraph “Compressor”);
- if the door remains open for longer than the value of par. Add, control resumes in any case. The light remains on, the measurement shown on the display flashes, the buzzer and the alarm relay are activated, and the temperature alarms are enabled with delay Ad.

Remote ON/OFF (par. DIF)

When the controller is OFF:

- the user terminal shows the value measured by the set probe (parameter /t1) alternating with the message OFF;
- the auxiliary relays set as AUX and light remain active, while the other auxiliary outputs are deactivated;
- the buzzer and alarm relay are deactivated;
- the following are not performed: control, defrosts, continuous cycle, temperature alarm signals;
- the compressor protection times are observed;
- switching ON from the keypad, supervisor or remote control is ignored.

When the controller is ON again, all the functions are reactivated, except for the defrost on start-up and compressor and evaporator fan delay on power-up (par. c0).

Note:

- the OFF command from digital input has priority over those from the keypad or supervisor;
- if the controller remains OFF for a longer time than the value set for parameter dl, a defrost is performed when the controller is switched on again.

Code	Description	Def	Min	Max	UOM	User	User terminal
DIF	Assign remote ON/OFF digital input - see DIA	0	-1	5	-	S	NO
dl	Maximum interval between consecutive defrosts	8	0	240	hours	S	YES
c0	Delay to enable solenoid/comp. and evap. fans on power-up	0	0	240	min	M	NO

Curtain switch (par. DIG)

During night status:

- the night-time set point St_n is used for control, calculated based on the set point St plus the offset defined by parameter $r4$ ($St_n = St + r4$). The control probe can also be modified according to the setting of parameter $r6$ (0 = virtual probe, 1 = air on probe), see the paragraph "Control";
- the AUX or light output is deactivated according to the setting of parameter H9.

During day status:

- normal operation resumes: set point = St , virtual probe used as control probe;
- AUX or light output activated according to the setting of parameter H9.

Code	Description	Def	Min	Max	UOM	User	User terminal
DIG	Assign curtain switch digital input - see DIA	0	-1	5	-	S	NO
H9	Output switched with time bands 0 = Light 1 = AUX	0	0	1	-	S	NO
r4	Automatic night set point variation	0	-50	50	°C/°F	S	NO
r6	Probe for night-time control 0/1 = virtual probe Sv/air on probe Sr	0	0	1	-	S	NO

Start/stop continuous cycle (par. DIH)

When the contact is closed, the continuous cycle is activated, based on parameters cc and c6 (see "Functions"). When the contact opens again, the continuous cycle is deactivated.

Code	Description	Def	Min	Max	UOM	User	User terminal
DIH	Assign start/stop continuous cycle digital input - see DIA	0	-1	5	-	S	NO

Digital input monitoring (par. DII)

The supervisor is able to detect the status of the digital input. The value is affected by reversing the logic of the input using parameter r11.

Code	Description	Def	Min	Max	UOM	User	User terminal
DII	Assign input status monitoring digital input - see DIA	0	-1	5	-	S	NO
rII	Input status monitoring digital input logic - see rIA	0	0	1	-	S	NO

Timed input (timer) (par. DIL)

The timed digital input is a special configuration that allows, in the transition from not active to active, the activation status of a specific digital variable to be maintained on the supervisor for a time set by parameter. To enable the function, select the desired digital input using parameter DIL.

Code	Description	Def	Min	Max	UOM	User	User terminal
DIL	Assign timed digital input - see DIA	0	-1	5	-	S	NO

When a digital input is configured as a timed digital input and a transition occurs from not active to active, the BAS_DIL "Timer" supervisor variable is set to ON and remains ON regardless of the physical status of digital input for the time set by parameter dIt. The value of parameter dIt can be set. Setting parameter dIt to 0 disables the function. The "Timer" variable can be associated with one or more AUX digital outputs (relays) by suitably setting the related parameter DOo to the value 13, thus aligning it with the status of the "Timer" variable. The timed digital input can be controlled not only by a physical digital input but also from the supervisor using the related digital control variable, with the same result. The same function can be used to set the "Timer" variable OFF regardless of whether or not the time set for parameter dIt has elapsed.

Special features:

- when the "Timer" variable is ON following the rising edge of a digital input, another transition from OFF to ON of the same digital input resets the timer;
- as it is possible to configure more than one output simultaneously as a replica of the "Timer" variable, following a transition of the variable, all of the outputs will switch simultaneously.

Code	Description	Def	Min	Max	UOM	User	User terminal
dIt	Timer duration (timed input) 0 = function disabled	0	0	999	min	S	NO
DOo	Assign timed digital output - see DOA	0	0	4	-	M	NO

Switch to Standby status (par. DIM)

Standby status is an intermediate state between ON and OFF: control is interrupted, the expansion valve is closed (0%), the control alarms and probe alarms remain active. ON status (normal operation) resumes after the time SIt has elapsed, after switching off (OFF status) or when the controller is restarted.

Code	Description	Def	Min	Max	UOM	User	User terminal
DIM	Assign Standby mode switch digital input - see DIA	0	-1	5	-	S	NO
SIt	Maximum time for Standby status	0	0	240	min	S	NO

Switch to Clean status (par. DIc)

Clean status is an intermediate state between ON and OFF: control is interrupted, the expansion valve is closed (0%), and only the probe alarms remain active.. ON status (normal operation) resumes after the time CLt has elapsed, after switching off (OFF status) or when the controller is restarted.

Code	Description	Def	Min	Max	UOM	User	User terminal
DIc	Assign Clean mode switch digital input - see DIA	0	-1	5	-	S	NO
CLt	Max time for Clean status	0	0	999	min	U	NO

The meaning of each status, OFF, ON, Standby and Clean, is summarised in the following table:

	Unit OFF	Unit ON	Standby	Clean
Control	OFF	ON	OFF	OFF
Light	independent	independent	independent	independent
Probe alarms	enabled	enabled	enabled	enabled
Other alarms	disabled	enabled	enabled	disabled
User terminal	OFF	based on /t1	Stb	CLn

Change working set (par. Dlo)

In this case, it is possible to choose between configuration 1 (digital input not active) and configuration 2 (digital input active). The changeover between sets occurs during the transition in status.

⚠ Important: when changing sets, the default parameters for the chosen configuration are loaded, and any settings made by the user will be overwritten.

🔧 Note: use the configuration software to set the two default configurations. (see "Installation").

Code	Description	Def	Min	Max	UOM	User	User terminal
Dlo	Assign working parameters set change digital input - see DIA	0	-1	5	-	S	NO

Door switch without stopping control (par. DIP)

Operating mode that allows the door to be opened without stopping control. In this case, when opening the door, only the light will switch on. This operating mode can be configured by setting parameter DIP with one of the digital inputs. Opening the door introduces a temperature alarm delay as described for the door switch function (par. DIE).

Code	Description	Def	Min	Max	UOM	User	User terminal
DIP	Assign door switch without control stop digital input - see DIA	0	-1	5	-	S	NO

Start/stop defrost from digital input (par. Dlr)

If configured in this new mode, a digital input can be used to start a defrost when closing and end the defrost when opening (independently of par. d0).

If the defrost ends after the maximum time (par. dP1), alarm Ed1 is activated, if enabled (r3 = 1).

Code	Description	Def	Min	Max	UOM	User	User terminal
Dlr	Assign defrost according to DI status digital input - see DIA	0	-1	5	-	S	NO
dP1	Maximum defrost duration	45	1	240	min	S	YES
r3	End defrost signal by timeout 0/1 = disabled/enabled	0	0	1	-	S	NO

5.1.3 Analogue outputs

In the MEDIUM version (see the paragraph "Models and accessories") MPXone features the following analogue outputs: Y1, Y2, either 0-10 V or PWM, configurable by parameter. The analogue outputs set as PWM can be used as a control signal to manage loads such as modulating evaporator fans or anti-sweat heaters, and require connection to a solid state relay (SSR).

Code	Description	Def	Min	Max	UOM	User	User terminal
/AA	Assign analogue output for modulating fans 0 = not configured 1 = analogue output 1 (Y1) 2 = analogue output 2 (Y2)	0	0	2	-	M	NO
/Ab	Assign analogue output for modulating valve - see /AA	0	0	2	-	M	NO
/Ac	Assign analogue output for modulating anti-sweat heaters - see /AA	0	0	2	-	M	NO

5.1.4 Digital outputs

MPXone has 4 digital outputs: NO1, NO2, NO3, NO4. To associate the digital outputs with the available functions, set parameters DOA, DOB, ... DOQ to the value of the physical digital output. See the parameter table.

Digital output functions

Digital output assignment for:	Par.	Default
Solenoid/compressor	DOA	Digital output 3 (NO3)
Alarm	DOb	-
Auxiliary	DOc	-
Auxiliary serving the MASTER on the SLAVES	DOd	-
Light	DOE	Digital output 4 (NO4)
Light serving the Master on the Slaves	DOF	-
Defrost	DOG	Digital output 1 (NO1)
Auxiliary evaporator defrost	DOH	-
Evaporator fans	DOI	Digital output 2 (NO2)
Output associated with the timer function	DOo	-
Condensate drain heater	DOP	-
Anti-sweat heater	DOQ	-

If the opposite logic to the default setting is required, or to correct a wiring error, the logic of the functions associated with the digital outputs using parameters rOA, rOb, ... rOp can be reversed.

Code	Description	Def	Min	Max	UOM	User	User terminal
rOA, rOb, ... rOp	Digital output logic ... 0/1 = direct /reverse	0	0	1	-	M	NO

Solenoid/compressor (par. DOA)

This allows the liquid solenoid valve to be used in applications with thermostatic expansion valves.

Code	Description	Def	Min	Max	UOM	User	User terminal
DOA	Assign solenoid/comp. digital output	3	0	4	-	S	NO
	0 = not set						
	1 = digital output 1 (NO1)						
	2 = digital output 2 (NO2)						

Alarm (par. DOB)

The relay associated with the alarm function can work as follows:

- normally de-energised: the relay is energised when an alarm occurs (rOA = 0);
 - normally energised: the relay is de-energised when an alarm occurs (rOA = 1);
- Note:** operation with the relay de-energised (rOA = 0) when an alarm occurs ensures maximum safety when the alarm is due to a power failure or power cable disconnection.

Code	Description	Def	Min	Max	UOM	User	User terminal
DOb	Assign alarm digital output - see DOA	0	0	4	-	S	NO

Auxiliary (par. DOc)

The actuator can be activated/deactivated using a command from the supervisor and based on the changeover in day/night status (linked to the curtain switch or the setting of the time bands); activation/deactivation of the actuator is signalled by the AUX icon switching on/off. The AUX output to be activated or deactivated based on the night/day time band can be selected (see parameters tS1...8, tE1...8 and H9).

Code	Description	Def	Min	Max	UOM	User	User terminal
DOc	Assign auxiliary digital output - see DOA	0	0	4	-	S	NO
H9	Output switched with time bands 0 = Light 1 = AUX	0	0	1	-	S	NO

Auxiliary serving the MASTER on the SLAVES (par. DOd)

From the Master, the action of the auxiliary output is broadcast via LAN to the Slaves whose digital output is configured with DOd greater than 0. Activation (or deactivation) of the actuator is signalled by the AUX icon switching on (off) on the Slave user terminal.

Code	Description	Def	Min	Max	UOM	User	User terminal
DOd	Assign auxiliary serving the Master on the Slaves digital output - see DOA	0	0	4	-	S	NO

Light (par. DOE)

The actuator can be activated/deactivated directly using the functions on the user terminal, using a command from the supervisor and based on the changeover in day/night status (linked to the curtain/door switch or the setting of the time bands); activation/deactivation of the actuator is signalled by the light icon switching on/off. The light output to be activated or deactivated based on the night/day time band can be selected (see parameters tS1...8, tE1...8 and H9).

Code	Description	Def	Min	Max	UOM	User	User terminal
DOE	Assign light digital output - see DOA	4	0	4	-	S	NO

Light serving the Master on the Slaves (par. DOF)

From the Master, the action of the light output is broadcast via LAN to the Slaves whose digital output is configured with DOF greater than 0. Activation (or deactivation) of the actuator is signalled by the light icon switching on (off) on the Slave user terminal.

Code	Description	Def	Min	Max	UOM	User	User terminal
DOF	Assign light serving the Master on the Slaves digital output - see DOA	0	0	4	-	S	NO

Defrost (par. DOG)

The actuator is activated/deactivated based on the defrost settings (see the paragraph "Defrost"). Activation/deactivation of the actuator is signalled by the defrost icon switching on/off on the user terminal.

Auxiliary evaporator defrost (par. DOH)

A heater can be activated for defrosting the main and auxiliary evaporator.

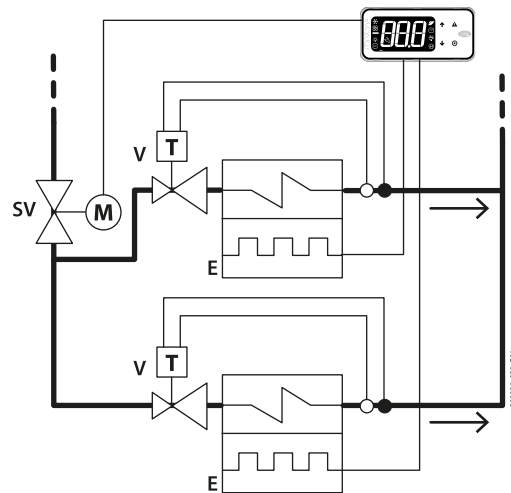

Fig.5.d

Ref.	Description	Ref.	Description
E	Evaporator with electric defroster	SV	Solenoid valve
V	Thermostatic expansion valve		

Note: this function is not compatible with management of the electronic expansion valve.

MPXone can manage defrosts with one or two outputs and one or two end defrost probes. The table below summarises the possible cases:

Defrost outputs	Evaporator probes	Control
1	1	normal
2	1	defrost managed on two outputs with reference to the same evaporator probe
1	2	defrost managed on the same output with reference to the two evaporator probes (minimum evaporation temperature)
2	2	defrost managed independently on the two evaporator circuits

Code	Description	Def	Min	Max	UOM	User	User terminal
/Fb	Assign defrost temperature probe (Sd) - see /FA	2	-4	6	-	S	NO
/FF	Assign defrost temperature probe 2 (Sd2) - see /FA	0	-4	6	-	S	NO
DOG	Assign defrost digital output - see DOA	1	0	4	-	S	NO
DOH	Assign auxiliary evaporator defrost digital output - see DOA	0	0	4	-	S	NO

Evaporator fans (par. DOI)

Once the digital output has been selected, the evaporator fan on/off is signalled by the the evaporator fan icon switching on/off on the display. See the paragraph "Evaporator fans"

Code	Description	Def	Min	Max	UOM	User	User terminal
DOI	Assign evaporator fan digital output - see DOA	2	0	4	-	M	NO

Condensate drain heater (par. DOP)

During defrosting there may be frozen condensate on the bottom of the cabinet that prevents the water thawed from the evaporator from being drained correctly. The digital output can be configured to manage the condensate drain heater function. The heater is started on activation of the pump down

stage and stays on throughout the defrost procedure, until the end of the dripping phase. The heater can be activated by selecting a digital output with par. DOP.

Note: the heater must be protected against overheating (e.g. thermal protector).

Code	Description	Def	Min	Max	UOM	User	User terminal
DOP	Assign drain heater digital output - see DOA	0	0	4	-	M	NO

Anti-sweat heater (par. DOQ)

Selection of the digital output for demisting the glass (control with fixed activation, see the paragraph about "Anti-sweat heaters").

Code	Description	Def	Min	Max	UOM	User	User terminal
DOQ	Assign anti-sweat heater digital output - see DOA	0	0	4	-	S	NO

5.2 Control

Introduction

There are various modes for controlling air temperature for the preservation of foodstuffs in cold rooms and showcases. The following figure shows the position of the intake probe (air on) *Sr* and the outlet probe (air off) *Sm*. The virtual probe *Sv* is a weighted average of these two, based on parameter */4*, according to the following formula:

$$Sv = \frac{Sm \cdot (100 - /4) + Sr \cdot (/4)}{100}$$

Code	Description	Def	Min	Max	UOM	User	User terminal
/4	Virtual probe composition 0 = Air off probe <i>Sm</i> 100 = Air on probe <i>Sr</i>	0	0	100	%	S	NO

For example, if */4*=50, $Sv=(Sm+Sr)/2$ represents an estimated value of the air temperature around the refrigerated food.

Note: HACCP: parameter */4* can be set to change the temperature used for control and for display. This operation may be prohibited by HACCP procedures or require record keeping and authorisation.

Example: vertical showcase

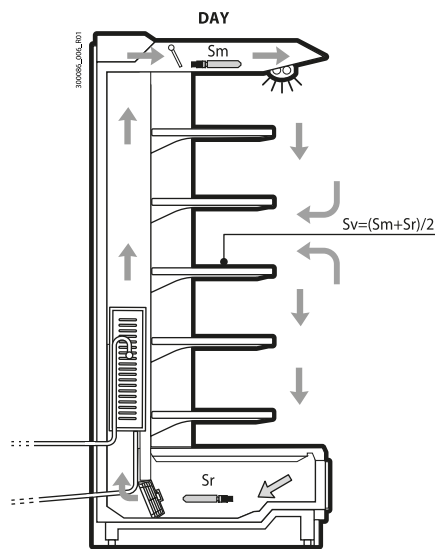

Fig.5.e

Ref.	Description	Ref.	Description
<i>Sm</i>	Outlet probe (air off)	<i>Sv</i>	Virtual probe
<i>Sr</i>	Intake probe (air on)		

During the day, most of the load in a refrigerated showcase is due to warm air that enters from the outside and mixes with the cold air inside. Control based on the intake probe, due to high temperature outside the showcase and the mixing of the air, may not manage to reach the set point. Displaying the intake temperature would show a temperature that is too high. Setting a set point that is too low for the intake probe *Sr* may cause the food to freeze. On the other hand, displaying the outlet temperature would show a temperature that is too low. Consequently, the display of the control probe, set point or virtual probe can be configured using parameters */t1* and */t2*.

ON/OFF control on the outlet (air off) probe is defined by:

- set point;
- differential

These values determine the control request and consequently, allowing for the protection times, disabling functions or activation/deactivation delays, the opening/closing of the solenoid valve.

Code	Description	Def	Min	Max	UOM	User	User terminal
St	Set point	50	r1	r2	°C/°F	U	YES
rd	Differential	2	0.1	20	°C/°F	U	YES

Note: HACCP: the set point and differential are critical parameters for food storage. Modifications to these settings may be prohibited by HACCP procedures or require record keeping and authorisation.

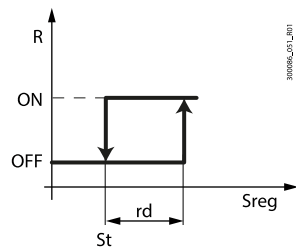

Fig.5.f

Ref.	Description	Ref.	Description
St	Set point	Sreg	Control probe
rd	Differential	R	Control request

ON/OFF control depends on the capacity of the produce to absorb and release heat, as well as on the evaporator cooling time. The temperature therefore fluctuates above and below the set point, and this may cause a decline in the quality of food preservation. Decreasing the differential to make control more precise increases the frequency of solenoid valve opening/closing cycles. Precision of the measurement is in any case limited by the tolerance of both the controller and the probe.

Minimum and maximum set point values (parameters r1 and r2)

The minimum and maximum value of the set point can be set by parameter.

Code	Description	Def	Min	Max	UOM	User	User terminal
r1	Minimum set point	-50	-50	r2	°C/°F	M	NO
r2	Maximum set point	50	r1	50	°C/°F	M	NO

Night-time operation

During night-time operation the curtain on the display case is closed and consequently less cold inside air is mixed with warm outside air. The thermal load decreases. The temperature of the air that cools the produce is near the outlet temperature, and therefore to avoid excessively low temperatures and reduce energy consumption, the set point needs to be increased at night, by setting parameter r4. Parameter r6 can then be used to possible the virtual probe Sv or intake probe (air on) Sr as the control probe. Naturally, the change to night-time operation must be signalled externally. This is usually done using the curtain switch, set with parameter DIG, signalling that the curtain has been lowered, or by setting the time bands (parameters tS1 to tS8 and tE1 to tE8), from the supervisor, or from the Master controller via the Master/Slave network. To set the time bands, see the paragraph "Setting the day/night time bands".

Code	Description	Def	Min	Max	UOM	User	User terminal
r4	Automatic night set point variation	0	-50	50	°C/°F	S	NO
r6	Probe for night-time control 0/1 = virtual probe Sv/air on probe Sr	0	0	1	-	S	NO
tS1..8-d	Start time band 1 to 8 day: day - see (td1...8-d)	0	0	11	day	S	NO

Code	Description	Def	Min	Max	UOM	User	User terminal
tS1..8- h	Start time band 1 to 8 day: hours	0	0	23	hours	S	NO
tS1..8-n	Start time band 1 to 8 day: minutes	0	0	59	minutes	S	NO
tE1..8-d	End time band 1 to 8 day: day - see (td1...8-d)	0	0	11	day	S	NO
tE1..8- h	End time band 1 to 8 day: hours	0	0	23	hours	S	NO
tE1..8-n	End time band 1 to 8 day: minutes	0	0	59	minutes	S	NO
PDM	Manufacturer password	44	0	99	-	M	NO
PDS	Service password	22	0	99	-	M	NO
PDU	User password	-	0	99	-	S	NO

🔔 **Note:** HACCP: verify that modification of the night-time set point (parameter /4) is permitted by site HACCP procedures. If required, obtain the required authorisation and record the changes.

Variable	Daytime control	Night-time control	
		r6 = 0	r6 = 1
Control probe (Sreg)	Virtual probe (Sv)	Virtual probe (Sv)	Intake probe (air on) (Sr)
Set point	St	St+r4	

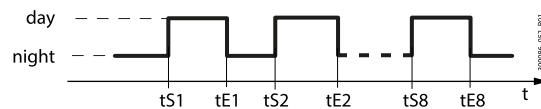

Fig.5.g

During day status:

- Set point = St
- light on
- control on virtual probe Sv

During night status:

- Set point = St + r4
- light off
- control on Sr (if r6=1) or on Sv (if r6=0)

“Weighted control” and “double thermostat” can be used for automatic changeover to night-time operation without an external signal.

Weighted control

This function compensates for the disadvantages of control based solely on the outlet (air off) probe or the intake (air on) probe. The control probe becomes the virtual probe:

$$Sv = \frac{Sm \cdot (100 - /4) + Sr \cdot (/4)}{100}$$

The weighted average of the outlet and intake probes is used to compensate for the mixing of air from outside the showcase. Normally the weight of /4 is set to 50% and the value of the virtual probe can be chosen for both display and temperature recording.

The value of the virtual probe thus becomes the mean value of the outlet (air off) and intake (air on) probes and the measurement that best corresponds to the temperature of the produce. Another advantage is automatic adaptation to night-time operation with the curtain closed, without needing an external signal. When the curtain is open there is immediately an increase in load on the evaporator, consequently the outlet temperature is lowered so as to keep the average temperature constant.

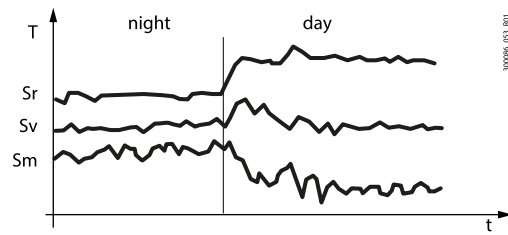

Fig.5.h

Ref.	Description	Ref.	Description
T	temperature	Sv	Virtual probe
t	time	Sm	Outlet probe (air off)
Sr	intake probe (air on)		

Shared network solenoid

If using solenoid valves, on Master controllers only the solenoid output (DOA) can be configured as a network solenoid output. The function is useful for multiplexed showcases: the network solenoid valve is only connected to the Master controller, which opens when at least one of the Slaves is in cooling request.

Code	Description	Def	Min	Max	UOM	User	User terminal	
DOA	Assign solenoid/comp. digital output	3	0	4	-	S	NO	
	0 = not set							3 = digital output 3 (NO3)
	1 = digital output 1 (NO1)							4 = digital output 4 (NO4)
	2 = digital output 2 (NO2)							
r7	Master solenoid valve configuration	0	0	1	-	S	NO	
	0/1 = local valve/network valve (connected to Master)							

If configured as the network solenoid, the valve is:

- open: if at least one of the controllers requires cooling;
- closed: if there is no control request or if at least one of the controllers has a serious valve alarm (low superheat, low suction temperature, high evaporation pressure), when suitably configured. See parameters P10 and PM5.

Code	Description	Def	Min	Max	UOM	User	User terminal
P10	Enable close solenoid valve for low superheat (LowSH) and/or low suction temp. (LSA)	0	0	1	-	M	NO
	1 = closing enabled						
PM5	MOP: close solenoid valve	0	0	1	-	S	NO
	0/1 = No/Yes						

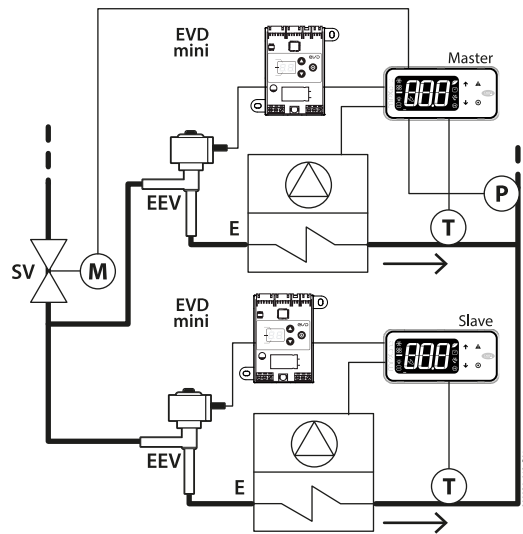

Fig.5.i

Ref.	Description	Ref.	Description
E	Forced-air evaporator	P	Evaporation pressure (PEu)
SV	Solenoid valve	T	Superheated gas temperature (tGS)
EEV	Electronic expansion valve		

ON/OFF (par. ON)

Parameter ON is used to switch the controller ON/OFF. If there is a digital input configured as remote ON/OFF, this has higher priority than the supervisor command or the ON parameter.

Code	Description	Def	Min	Max	UOM	User	User terminal
ON	ON/OFF control 0/1: OFF/ON	0	0	1	-	S	YES

In this operating mode, the display shows the standard display, alternating with the message "OFF".

When OFF, the following are possible:

- access the parameters on the user terminal;
- select the probe to be displayed, using the APPLICA app;
- activate remote ON/OFF;
- display the probe alarms (rE, E1, E2, E3, etc.) and errors EE, EF, Etc, Edc, alternating with the message OFF.

When OFF, the following alarms are reset:

- high and low temperature;
- open door alarm (dor);
- valve (LSA, LowSH, MOP).

Double thermostat

The double thermostat function is activated by setting parameter rd2 > 0 and selecting mode AND or OR logic mode (parameter db1). It is used to adapt automatically, that is, without changing the set point and without an external signal, control of the unit based on a change in compressor load, especially when switching from day to night and vice-versa. In fact, at night the showcase curtains are closed, there is less heat exchange with the surrounding air and the compressor works less.

To do this, two set points and two differentials are defined:

- St and rd, associated with the outlet probe (air off);
- St2 and rd2, associated with the intake probe (air on).

Code	Description	Def	Min	Max	UOM	User	User terminal
St2	Air on probe set point with double thermostat	50	r1	r2	°C/°F	S	NO
rd2	Set point St2 differential with double thermostat 0.0 = function disabled	0	0	20	°C/°F	S	NO
db1	Double thermostat function logic 0/1: AND logic/OR logic	0	0	1	-	M	NO

The control request occurs:

- when this is active on both probes, as if there were two thermostats in series, when db1 = 0. At night the intake probe is controlled and the outlet probe always signals the request, in the day the outlet probe is controlled and the intake probe always signals the request.
- when one of the probes signals the request, as if there were two thermostats in parallel, when db1 = 1

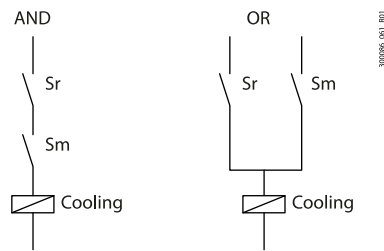

Fig.5.j

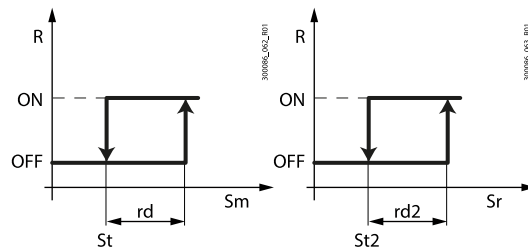

Fig.5.k

Ref.	Description	Ref.	Description
Sm	outlet probe (air off)	rd	differential for St
Sr	intake probe (air on)	rd2	differential for St2
R	control request		

Below is an example of the temperature trend on a vertical showcase during the day and at night.

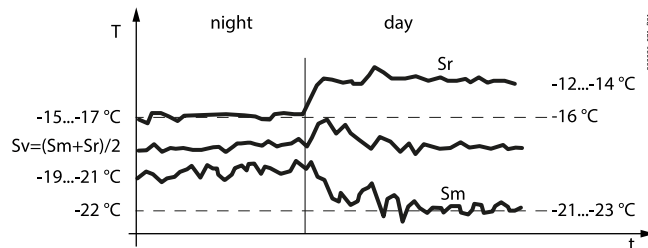

Fig.5.l



Ref.	Description
Sm	outlet probe (air off)
Sr	intake probe (air on)
T	temperature

Ref.	Description
Sv	Virtual probe
t	time

Daytime status: Sm = -21 to -23°C, St = -22°C

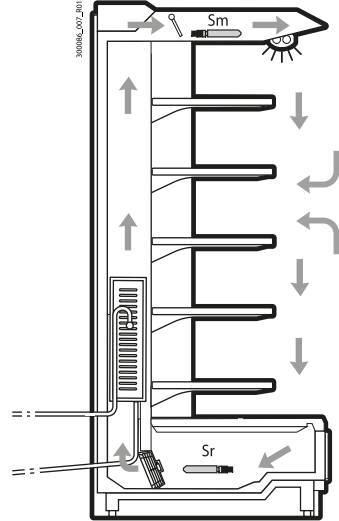

Sr = -12 to -14°C, St = -16°C

Fig.5.m

Night-time status: Sm = -19 to -21°C, St = -22°C

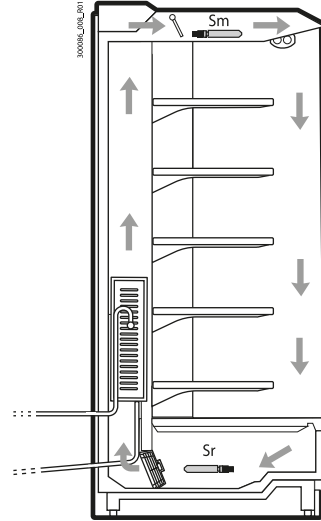

Sr = -17 to -15°C, St = -16°C

Fig.5.n

Ref.	Description
Sm	outlet probe (air off)
Sr	intake probe (air on)

Note:

- if one of the probes has an error or is missing, it is considered as signalling the request;
- if both probes are faulty or missing, the controller switches to duty setting mode.

⚠ Important: if the double thermostat function is activated, the setting of the following parameters has no effect:

- r6 (night-time control probe);
- r4 (automatic night-time set point variation).

Control offset with probe error (parameter ro)

Code	Description	Def	Min	Max	UOM	User	User terminal
ro	Control offset with probe error	0	0	20	°C/°F	S	NO

MPXone in standard mode uses the virtual probe Sv for control, that is, the weighted average of the outlet and intake probe (see parameter /4). If one of the two probes making up the virtual probe is broken or has an error, parameter ro is used to continue normal control in controlled conditions, without the need for immediate intervention by maintenance personnel. The recommended value of ro is the temperature difference between the outlet probe and intake probe reading in steady operating conditions of the refrigeration unit:

$$ro = Sr - Sm$$

The following cases may occur:

- outlet probe (air off) Sm error: MPXone starts control based on the intake probe Sr alone, considering a new set point (St*) determined by the formula:

$$St^* = St + ro \cdot \frac{(100 - \cdot /4^2)}{100}$$

- intake probe (air on) Sr error: MPXone starts control based on the outlet probe Sm alone, considering a new set point (St*) determined by the formula:

$$St^* = St - ro \cdot \frac{r4}{100}$$

If night-time operation has been set with the intake probe as the control probe, the controller considers r4=100 and uses the outlet probe. The new set point becomes:

$$St^* = St - ro$$

Note:

- if ro=0 the function is not active;
- for night-time operation the new set point is added to the value defined by r4 (= automatic night-time set point variation);
- in the event of errors on both probes, the controller switches to duty setting operation.

Example

Sm fault in daytime operation, with r4=50, St=-4, Sr=0, Sm=-8, ro (recommended) = 0-(-8) = 8. Then the new control probe will be Sr with:

$$St^* = St + ro \cdot \frac{(100-r4)}{100}$$

St* = -4+8 (100-50)/100=0.

If the fault is on Sr, the new control probe will be Sm with:

$$St^* = St - ro \cdot \frac{r4}{100}$$

St* = -4-8 · 50/100=-8.

ON time for duty setting operation (par. c4)

Duty setting is a special function used to maintain control in emergency situations with errors in the temperature control probes, until a service intervention. In the event of a temperature probe error, MPXone uses the other probe available and adjusts the set point according to the setting of parameter ro. In the event of errors on both probes, MPXone switches to a special mode called “duty setting”. The controller is activated at regular intervals, operating for a time equal to the value set for the duty setting parameter c4, and off for a fixed time of 15 minutes.

Code	Description	Def	Min	Max	UOM	User	User terminal
c4	ON time for duty setting operation (Toff = 15 minutes fixed) 0 = compressor/valve always OFF 100 = compressor/valve always ON	0	0	100	min	M	NO

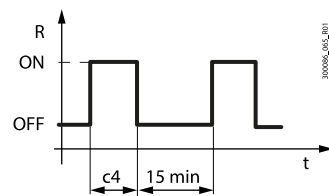

Fig.5.o

Ref.	Description	Ref.	Description
R	Control	t	Time
c4	ON time		

With duty setting active, during the ON time the solenoid/compressor icon remains on, while it flashes during the OFF time.

The table below describes the possible fault situations relating to the control probes and the function that is activated.

Type of system	Control probe fault		Control	Parameter
	Sm	Sr		
1 probe	●		Duty setting	c4
		●	Duty setting	c4
2 probes	●		control on Sr	ro(*)
		●	control on Sm	ro(*)
	●	●	Duty setting	c4

* ro must be > 0.

Duty setting with shared control status

The activation of the duty setting mode is signalled on the Master user interface by the solenoid/compressor icon on steady; the Slave controllers ignore the Master control mode. On the other hand, if a Slave activates duty setting mode due to lack of communication with the Master, the Slave manages the display on the user interface as envisaged.

Note:

- Activation of duty setting mode on the Master controller implies that all the related Slaves observe the Master controller compressor management times.
- in duty setting mode, the compressor protection times are ignored.



Continuous cycle (parameter cc)

Continuous cycle is a function used to keep the refrigeration cycle active continuously for a settable duration, irrespective of the temperature inside the unit. This may be useful when requiring a rapid decrease in the temperature, even below the set point. Activation of the low temperature alarm when exceeding the threshold AL or AL2 can be delayed by setting parameter c6.

Important: the unit of measure of parameter cc is hours

Code	Description	Def	Min	Max	UOM	User	User terminal
cc	Running time in continuous cycle 0 = Disabled	1	0	15	hours	M	NO
c6	Low temp. alarm bypass time after continuous cycle	60	0	240	min	M	NO

The continuous cycle is activated using the direct continuous cycle function on the user terminal (see the paragraph "Direct functions"), from the supervisor or via digital input. When the continuous cycle is running:

- the  +  icons are displayed.
- the solenoid/compressor valve output (with icon) and electronic valve control are activated;
- the low temperature alarm with threshold AL is enabled relating to the probe defined by parameter AA as well as the low temperature alarm with threshold AL2 relating to the probe defined by parameter AA2.

Important: for the correct activation of the low temperature alarms, set the parameters as follows:

- AA = outlet probe (air off);
- AA2 = intake probe (air on).

Note:

1. The continuous cycle cannot be activated if:
 - the duration of the continuous cycle is set to 0 (cc=0);
 - the measurements of the probes defined by AA and AA2 have exceeded their respective thresholds AL, AL2;
 - the device is OFF.
2. The continuous cycle remains in standby if:
 - the compressor protection times are set (c1, c2, c3);
 - the immediate or delayed alarm from external digital input delays activation of the solenoid

- valve;
 - defrost, dripping, post-dripping are running;
 - the door is open. When the door is opened, the continuous cycle is interrupted. It restarts for the remaining time when the door is closed.
3. The continuous cycle ends:
- when deactivating the direct function from the user terminal (see the paragraph "Direct functions");
 - when reaching the low temperature threshold (AL or AL2 in double thermostat), whichever is reached first;
 - at the end of the time cc;
 - when the controller is switched off from the supervisor (logical OFF);
 - from the supervisor.

Continuous cycle with shared control status

This operating mode is highlighted on the Master user interface by the corresponding icons on steady; the Slave controllers ignore the Master control mode and manage the display as normal (solenoid icon on during the cooling request and off when there is no request).

Defrost priority over continuous cycle

Code	Description	Def	Min	Max	UOM	User	User terminal
c7	Defrost priority over continuous cycle 0/1 = No/Yes	0	0	1	-	M	NO

If c7=0 the defrost and continuous cycle are not mutually interruptible (same priority): any defrost or continuous cycle request remains pending if activated when running the other procedure. If c7=1 the defrost calls activated when the continuous cycle is running terminate the latter and activate the defrost.

5.3 Defrost

Introduction

Parameters td1 to td8 can be used to set up to 8 defrost events based on the controller clock (RTC) and to activate the Power Defrost (see the end of the paragraph).

To set parameters td1 to td8, use the supervisor or the "Applica" app.

Code	Description	Def	Min	Max	UOM	User	User terminal
td1..8-d	Defrost 1 to 8 - day 0 = event disabled 1 to 7 = Monday to Sunday 8 = from Monday to Friday 9 = from Monday to Saturday 10 = Saturday & Sunday 11 = every day	0	0	11	day	S	NO
td1..8- h	Defrost 1 to 8 - hours	0	0	23	hours	S	NO
td1..8-n	Defrost 1 to 8 - minutes	0	0	59	minutes	S	NO
td1..8-P	Defrost 1 to 8 - enable power defrost: 0/1 = normal/power defrost	0	0	1	-	S	NO

MPXone can manage the following types of defrost, depending on the setting of parameter d0:

- heater, placed near the evaporator;

The defrost can end by temperature, in which case the defrost probe Sd must be installed, or by time. In the first case the defrost ends when the defrost probe Sd exceeds the end defrost value dt1 or the time dP1 has elapsed, in the second case when the defrost phase exceeds the maximum time dP1. At the end of the defrost the dripping phase may begin (if dd>0), during which the solenoid valve is closed and the fans are off, followed by the post-dripping phase (if Fd>0), during which control resumes and the fans work based on the setting of par. Fpd. The type of display on user terminal and the remote display during the defrost can be selected by setting parameter d6.

Note: high temperature alarms can be disabled after defrosting by setting par. d8

Code	Description	Def	Min	Max	UOM	User	User terminal
d0	Type of defrost 0 = heater by temperature 1 = reserved 2 = heater by time 3 = reserved 4 = heater by time with temperature control	0	0	4	-	S	YES
dt1	End defrost temperature (read by Sd)	8	-50	50	°C/°F	S	YES
dP1	Maximum defrost duration	45	1	240	min	S	YES
d6	Display on terminals during defrost 0 = temperature alternating with 'dEF' 1 = freeze display 2 = 'dEF'	1	0	2	-	U	NO
d8	Bypass high temperature alarm time after defrost	30	1	240	min	S	NO
F3	Evaporator fans during defrost 0/1 = on/off	1	0	1	-	S	NO
Fd	Post-dripping time after defrost (fans off with control active)	1	0	15	min	S	NO
Fpd	Evaporator fans during post-dripping 0/1 = On/Off	0	0	1	-	0	NO

Below is the trend of the defrost output based on the setting of parameter d0.

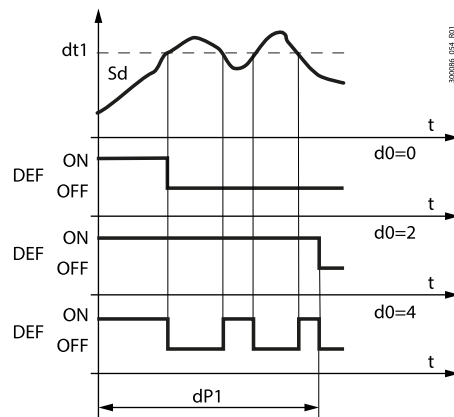

Fig.5.p

Ref.	Description	Ref.	Description
t	Time	Sd	Defrost probe
dt1	End defrost temperature	DEF	Defrost
dP1	Maximum defrost duration		

The heater defrost by time with temperature control (d0=4) activates the defrost output only if the evaporator temperature (Sd) is less than the value of parameter dt1, and ends after the time defined by dP1. This function is useful for energy saving and to prevent excessive temperatures on the evaporator.

5.3.1 Heater defrost (d0 = 0, 2, 4): duty cycle

The duty cycle refers to the default values of parameters F2 and F3. The electronic valve can be opened to the initial value set for cP1 for a period equal to Pdd.

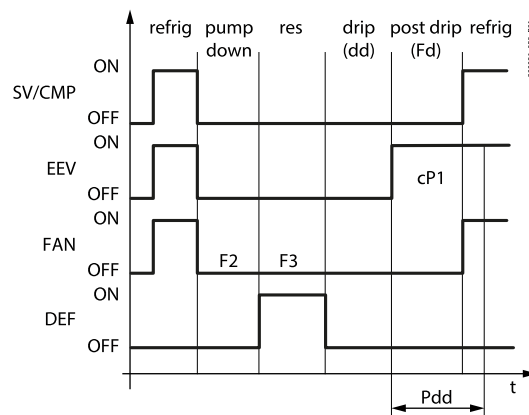

Fig.5.q

Ref.	Description	Ref.	Description
t	Time	SV/CMP	Solenoid/compressor
FAN	Fan	EEV	Electronic expansion valve
DEF	Defrost	Pdd	Valve position maintenance time after defrost
drip	Dripping	Post drip	Post-dripping

Fig.5.r

The pump down phase is the period in which the evaporator is emptied of liquid refrigerant, and can be disabled by setting dH1=0 (see the paragraph "Pump down phase duration"). Operation of the fan

during the pump down and hot gas phases depends on parameters F2 and F3. During the dripping phase the fan is always off, while during the post-dripping phase operation depends on the setting of parameter Fpd.

Code	Description	Def	Min	Max	UOM	User	User terminal
dd	Dripping time after defrost (fans off) 0 = no dripping	2	0	15	min	S	NO
dH1	Pump down phase duration 0 = pump down disabled	0	0	999	s	M	NO
F2	Evaporator fans with compressor off 0 = see F0 1 = always off	1	0	1	-	S	NO
F3	Evaporator fans during defrost 0/1 = on/off	1	0	1	-	S	NO
Fd	Post-dripping time after defrost (fans off with control active)	1	0	15	min	S	NO
cP1	Initial valve position when control starts	30	0	100	%	M	NO
Pdd	Initial valve position maintenance time after defrost	10	0	30	min	S	NO
dSb	Valve position during defrost 0: as defined by the type of defrost 1: forced closed 2 to 100: opening percentage	0	0	100	%	M	NO

5.3.2 Advanced parameters

Maximum interval between consecutive defrosts (par. dl)

Code	Description	Def	Min	Max	UOM	User	User terminal
dl	Maximum interval between consecutive defrosts	8	0	240	hours	S	YES

Parameter dl is a safety parameter used to perform cyclical defrosts every "dl" hours. It is also useful if the LAN or RS485 serial network is disconnected. At the start of each defrost, irrespective of the duration, an interval starts being counted. If this interval exceeds dl without a defrost being performed, one is started automatically. The count is always active even if the controller is OFF. If set on the Master controller, the parameter affects the entire connected LAN subnet, while if set on a Slave controller, it only has an effect locally.

Example.

If the defrosts are controlled by a centralised system and there is no communication, the request will not be received, so after the safety time a defrost is started automatically.

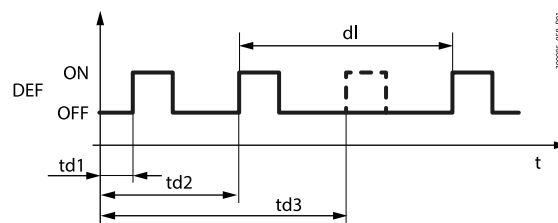

Fig.5.s

Ref.	Description	Ref.	Description
dl	Maximum interval between consecutive defrosts	t	time
td1...td3	Scheduled defrosts	DEF	Defrost

Staggered defrosts

The function is used to perform a series of daily defrosts by setting just the first using parameter td1 and then indicating the number of defrosts per day using parameter d1S. The controller automatically schedules all the defrosts to be performed at regular intervals over the 24 hours following the event defined by td1. The same applies to td2 and d2S.

Code	Description	Def	Min	Max	UOM	User	User terminal		
d1S	Number of daily defrosts (td1)								
	0 = Disabled	5 = 4 ore 48 minutes	10 = 2 hours and 24 minutes						
	1 = 24 ore 0 minutes	6 = 4 ore 0 minutes	11 = 2 hours and 11 minutes						
	2 = 12 ore 0 minutes	7 = 3 ore 26 minutes	12 = 2 hours and 0 minutes	0	0	14	-	S	NO
	3 = 8 ore 0 minutes	8 = 3 hours and 0 minutes	13 = 1 hour and 0 minutes						
	4 = 6 ore 0 minutes	9 = 2 hours and 40 minutes	14 = 30 minutes						
d2S	Number of daily defrosts (td2) - see d1S	0	0	14	-	S	NO		

Remember that the sub-parameter "d_" of td1 (td2) defines the defrost day, as follows:

d_ = Defrost - day	
0 = event disabled	9 = from Monday to Saturday
1 to 7 = Monday to Sunday	10 = Saturday & Sunday
8 = Monday to Friday	11 = every day

Note:

- if event td1 includes a series of days, the programming always ends at 24.00 on the last day. If event td1 includes one day only, the programming ends at 24.00 on the same day;
- if both td1 and td2 are set, when the defrost events overlap, only the sequence of defrosts that start first are performed..

Start/ end defrost synchronised by Master (par. d2, d3)

Code	Description	Def	Min	Max	UOM	User	User terminal
d2	End defrost synchronised by Master 0/1 = not synchronised/synchronised	1	0	1	-	S	NO
d3	Send network start defrost command (for Master) 0/1: yes/no Ignore network start defrost command (for Slave) 0/1: no/yes	0	0	1	-	S	NO

The parameter determine whether or not, in a local network, MPXone awaits a start/end defrost signal from the Master at the start/end of the defrost.

End defrost signal by timeout (par. r3)

Code	Description	Def	Min	Max	UOM	User	User terminal
r3	End defrost signal by timeout 0/1 = disabled/enabled	0	0	1	-	S	NO

For defrosts that end by temperature (d0=0) , this enables the end defrost by timeout signals Ed1 and Ed2.

Defrost on power-up (par. d4)

Code	Description	Def	Min	Max	UOM	User	User terminal
d4	Defrost on power-up (Master = network defrost; Slave = local defrost) 0/1 = No/Yes	0	0	1	-	S	NO

The defrost call on power-up has priority over the control request and activation of the continuous cycle. For Master controllers, the defrost on power-up will be a network defrost; for Slave controllers it will be local.

Defrost delay on power-up (parameter d5)

Code	Description	Def	Min	Max	UOM	User	User terminal
d5	Defrost delay on power-up or (for Slave) after control from Master 0 = delay disabled	0	0	240	min	S	NO

Also active when d4=0. If the digital input is set to enable or start a defrost from an external contact, parameter d5 represents the delay between when the defrost is enabled or called, and when it effectively starts.

For Mater/Slave networks where the defrost needs to be activated from a digital input on the Master, use parameter d5 to delay the various defrosts, thus avoiding current overloads.

Note: to avoid unwanted defrosts controlled by the controller timer, set parameter dI=0 (defrosts from keypad, RTC, compressor running time or digital input only).

Dripping time after defrost (par. dd)

Code	Description	Def	Min	Max	UOM	User	User terminal
dd	Dripping time after defrost (fans off) 0 = no dripping	2	0	15	min	S	NO

This parameter is used to stop the compressor and the evaporator fans following a defrost so as to allow the evaporator to drip. The value of the parameter indicates the off time in minutes. If dd=0 no dripping time is enabled, and at the end of the defrost control resumes immediately, without stopping the compressor and the fan, if active.

Valve positioning during defrost (par. dSb)

A fixed position (as a percentage) can be set for valve opening throughout the defrost procedure, from the end of pump-down to the start of the dripping phase. The valve will behave as defined by parameters cP1 and Pdd starting from the post-dripping phase. The opening percentage is applied in all the types of defrost. The function is activated by setting parameter dSb to a value between 1 and 100; this value indicates the position of the valve as a % of the number of steps (not capacity).

Setting the parameter to 1, the valve is closed completely during defrost. Setting the parameter to 0, positioning is disabled and the valve will behave as defined for the type of defrost selected.

Code	Description	Def	Min	Max	UOM	User	User terminal
dSb	Valve position during defrost 0: as defined by the type of defrost 1: forced closed 2 to 100: opening percentage	0	0	100	%	M	NO

Pump down phase duration (par. dH1)

Code	Description	Def	Min	Max	UOM	User	User terminal
dH1	Pump down phase duration 0 = pump down disabled	0	0	999	s	M	NO

The pump down phase is the period in which the evaporator is emptied of liquid refrigerant. Parameter dH1 defines the duration of the pump down phase during all types of defrost, heater or hot gas.

⚠ Important: the controller does not have two separate outputs to manage the compressor and solenoid valve.

Running time defrost (par. d10, d11)

Running time is a special function that determines when the refrigeration unit needs defrosting. In particular, it is assumed that if the evaporator temperature measured by probe Sd remains continuously below a certain set threshold (d11) for a certain time (d10), the evaporator may be frozen and a defrost is activated. The time is reset if the temperature returns above the threshold.

Code	Description	Def	Min	Max	UOM	User	User terminal
dt1	End defrost temperature (read by Sd)	8	-50	50	°C/°F	S	YES
dt2	End defrost temperature (read by Sd2)	8	-50	50	°C/°F	S	NO
d10	Defrost time in Running time mode 0 = function disabled	0	0	240	min	S	NO
d11	Defrost temperature threshold in Running time mode	-30	-50	50	°C/°F	S	NO

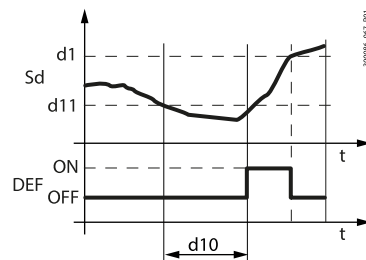

Fig.5.t

Ref.	Description	Ref.	Description
Sd	Defrost probe	t	time
DEF	Defrost		

Pressure probe alarm management during defrost (par. d12)

During defrosts and dripping, so as to avoid false pressure probe error signals, errors are ignored. The supervisor update also needs to be disabled.

Code	Description	Def	Min	Max	UOM	User	User terminal		
d12	Pressure probe alarm management during defrost	0	0	3	-	M	NO		
	probe error							supervisor update	
	0							disabled	enabled
	1							enabled	enabled
	2							disabled	disabled
3	enabled	disabled							

Sequential stops (par. dS1, dS2)

Code	Description	Def	Min	Max	UOM	User	User terminal
dS1	Compressor off time in sequential stop defrost mode 0 = function disabled	0	0	45	min	M	NO
dS2	Compressor operating time in sequential stop defrost mode	120	0	240	min	M	NO

Sequential stop mode is especially useful for medium temperature refrigeration units, and is based on the intelligent stopping of control to allow the evaporator to defrost naturally by the flow of ambient air only, without activating the defrost output. If the function is enabled (parameter dS1>0), two countdowns are activated during normal control:

- OFFTIME: counts down during the stop time and on hold during control;
- ONTIME: counts down during control and on hold during the stop time.

Two events may occur, with reference to the following figure:

1. OFFTIME is reset (instant C): OFFTIME and ONTIME are reset with the values dS1 and dS2 and the defrost is considered completed. Control resumes;
2. ONTIME is reset (instant A): OFFTIME is reset with the default value and the natural defrost starts, lasting the entire time dS1. At the end of the defrost (instant B), OFFTIME and ONTIME are reset with the values dS1 and dS2 and control resumes.

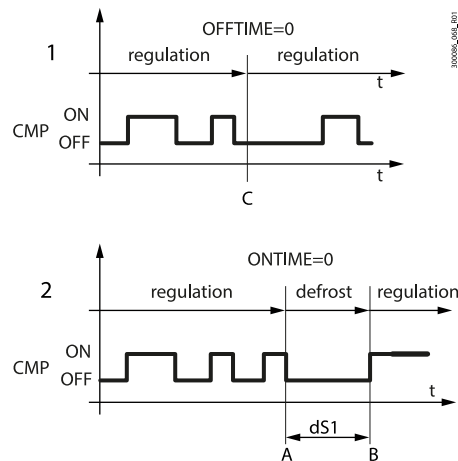

Fig.5.u

Ref.	Description
CMP	Compressor
t	time

The purpose is to stop control and allow natural defrosts only when necessary.

When control stops in sequential stop mode, the defrost icon will come on, the defrost status will be sent to the supervisor and the display will reflect the setting of parameter d6.

🔍 **Note:** the setting of parameter F3 has no effect. Evaporator fan management depends on parameter F0.

Skip defrost (par. d7, dn)

This function applies to defrosts that end by temperature, otherwise it has no effect. The skip defrost function evaluates whether the defrost duration is less than a certain threshold dn1 (dn2) and based on this establishes whether or not the following defrosts will be skipped.

Code	Description	Def	Min	Max	UOM	User	User terminal
dP1	Maximum defrost duration	45	1	240	min	S	YES
dP2	Max secondary evap. defrost duration	45	1	240	min	S	NO
d7	Skip defrost 0/1 = disabled/enabled	0	0	1	-	S	NO
dn	Nominal skip defrost duration	75	0	100	%	S	NO

Thresholds dn1 (evaporator 1) and dn2 (evaporator 2) are defined by:

$$dn1 = \frac{dn}{100} \cdot dP1, \quad dn2 = \frac{dn}{100} \cdot dP2$$

The algorithm keeps a counter of the defrosts to be skipped:

- if the defrost ends in a time less than dn1, the counter of the defrosts to be skipped is increased by 1;
- if the defrost ends normally, the next defrost is performed;
- when the counter reaches 3, three defrosts are skipped and then the counter is reset to 1;
- on power-up, the defrost is performed 7 times without increasing the counter, from the eighth on the counter is updated.

➔ **Note:** in power defrost mode, the maximum defrost durations dP1 and dP2 are increased by the value of parameter ddP.

Power defrost (par. ddt, ddP)

Power defrost is used to increase the end defrost threshold dt1 (dt2 for the second evaporator) and/or the maximum defrost duration dP1 (dP2 for the second evaporator). These increases allow more effective defrosts. Power defrosts are performed on each defrost call during night status or when suitably configured by the RTC parameters (sub-parameter P of parameters td1 to td8), so as to allow the user to choose the conditions that are most suitable for this special procedure. Power defrost is activated when at least one of the increases, ddt or ddP, has any value other than zero.

Code	Description	Def	Min	Max	UOM	User	User terminal
ddt	Additional end defrost temperature delta in power defrost mode	0	-20	20	°C/°F	S	NO
ddP	Additional maximum defrost time delta in power defrost mode	0	0	60	min	S	NO
td1.8-P	Defrost 1 to 8 - enable power defrost: 0/1 = normal/power defrost	0	0	1	-	S	NO

5.4 Evaporator fans

The evaporator fans can be managed, if required, according to the temperature measured by any two of the probes connected to the MPXone controller. The deactivation threshold is equal to the value of parameter F1, and the hysteresis is equal to the value of Frd.

➔ **Note:** during the dripping waiting time (in the event of network defrosts), and during the dripping time, the evaporator fans are always off, while during the post-dripping time, if set, evaporator fan operation depends on the setting of par. Fpd.

Fixed-speed fans

The parameters used to manage fixed-speed fans are shown below (see the connection diagram).

MPXone manages the evaporator fans as follows:

- F0 = 0 always on;
- F0 = 1 off when the difference between the two probe values Sa and Sb (defined by parameters FSa and FSb) exceeds the threshold set for parameter F1;
- F0 = 2 on/off based on Sa probe, defined by parameter FSa.



Code	Description	Def	Min	Max	UOM	User	User terminal
F0	Evaporator fan management 0 = always on 1 = activation based on Sa - Sb (see FSa and FSb) 2 = activation based on Sa (Sa = first probe, Sb = second probe)	0	0	2	-	S	YES
F1	Evaporator fan activation threshold (only if F0 = 1 or 2)	-5	-50	50	°C/°F	S	YES
Frd	Fan activation differential (including variable speed)	2	0.1	20	°C/°F	S	YES
FSa	First fan control probe 0: Not configured 1: Air off (Sm) 2: Defrost (Sd) 3: Air on (Sr) 4: Superheated gas (tGS) 5: Saturated evaporation pressure (PEu) 6: Defrost 2 (Sd2) 7: Auxiliary 1 (Saux1) 8: Auxiliary 2 (Saux2) 9: Ambient (SA) 10: Ambient humidity (SU) 11: Glass temperature (Svt) 12: Dewpoint (SdP) 13: Saturated evaporation temperature (tEu)	3	0	13	-	M	NO
FSb	Second fan control probe - see FSa	14	0	14	-	M	NO

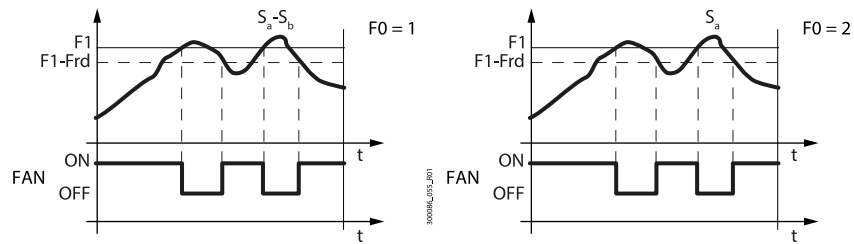

Fig.5.v

Ref.	Description	Ref.	Description
Sa	Probe set by parameter FSa	Frd	Differential
Sb	Probe set by parameter FSb	t	time
F1	Fan activation threshold	FAN	Evaporator fans

The fans can be turned off in the following situations:

- when the solenoid valve is deactivated (parameter F2);
- during defrosts (parameter F3).

During the dripping time (parameter dd > 0) the fans are off, and during the post-dripping time (parameter Fd > 0), the evaporator fans are on or off depending on the value of parameter Fpd.

This is useful to allow the evaporator to return to temperature after defrosting, thus avoiding blowing warm hot and moist air into the refrigerated environment.

The evaporator fans can be forced on during control (parameter F2) and during defrosts (parameter F3).

Code	Description	Def	Min	Max	UOM	User	User terminal
dd	Dripping time after defrost (fans off) 0 = no dripping	2	0	15	min	S	NO
F2	Evaporator fans with compressor off 0 = see F0	1	0	1	-	S	NO

Code	Description	Def	Min	Max	UOM	User	User terminal
	1 = always off						
F3	Evaporator fans during defrost 0/1 = on/off	1	0	1	-	S	NO
Fd	Post-dripping time after defrost (fans off with control active)	1	0	15	min	S	NO
Fpd	Evaporator fans during post-dripping 0/1 = On/Off	0	0	1	-	0	NO

Variable-speed fans (EC fans)

The installation of variable-speed fans may be useful in optimising energy consumption. In this case, the fans are powered by the mains, while the control signal may come via output Y1 or Y2, set as 0-10 Vdc.

Note: this function is only available on models with analogue outputs (Y1, Y2)

The maximum and minimum fan speed can be set using advanced parameters F6 and F7.

If using the fan speed controller, F5 represents the temperature below which the fans are activated. There is a fixed hysteresis of 1°C for deactivation.

Code	Description	Def	Min	Max	UOM	User	User terminal
F5	Evap. fan cut-off temperature (hyst. 1°C)	50	F1	50	°C/°F	S	NO

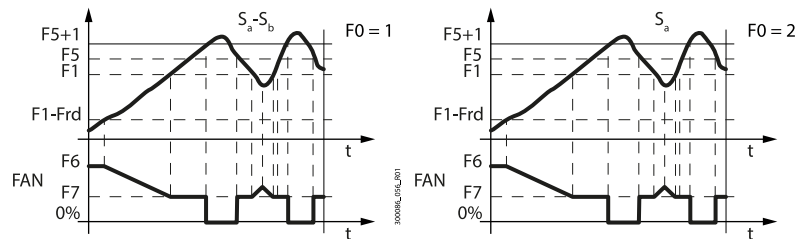

Fig.5.w

Ref.	Description	Ref.	Description
Sa	Probe set by parameter FSa	Frd	Differential
Sb	Probe set by parameter FSb	t	time
F5	Fan cut-off temperature	FAN	Evaporator fans
F1	Fan activation threshold		

The advanced parameters for the evaporator fans concern the minimum and maximum speed and the peak time.

Code	Description	Def	Min	Max	UOM	User	User terminal
F6	Max evaporator fan speed	100	F7	100	%	M	NO
F7	Min evaporator fan speed	0	0	F6	%	M	NO
F8	Evaporator fan peak time 0 = Function disabled	0	0	240	s	M	NO
F10	Evaporator fan forcing time at max speed 0 = Function disabled	0	0	240	min	M	NO

F6: is the maximum fan speed, expressed as a % of the output. For 0 to 10 V outputs, it represents the output voltage at maximum speed as a percentage. The same is true for the minimum speed set for F7.

The fan peak time F8 represents the operating time at maximum speed set using parameter F6 to overcome the mechanical inertia of the motor.

F10 represents the frequency at which the fan is operated at maximum speed for the peak time (F8). If the fan operates too long at low speed, ice may form on the blades; to avoid this, at intervals of every F10 minutes, the fan is switched on at maximum speed for the time set for parameter F8.

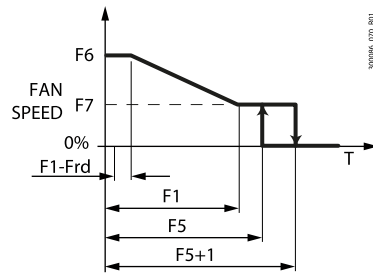

Fig.5.x

Ref.	Description	Ref.	Description
T	temperature	F5	Fan cut-off temperature
F1	Fan activation threshold	F6	Maximum speed
Frd	Differential	F7	Minimum speed

5.5 Anti-sweat heater or fan modulation

The control of anti-sweat heaters is performed by comparing the dew point calculated based on the ambient temperature and humidity, and the temperature of the showcase glass, measured by a probe or estimated using the showcase outlet, intake and ambient temperature. MPXone features two types of anti-sweat heater control:

- PI (proportional, integral);
- fixed activation (manual control).

The conditions for the activation of the algorithms are as follows:

Algorithm	Activation condition
PI	rHd > 0
fixed activation (manual control)	rHd = 0; rHt > 0

If the temperature read by the glass temperature probe is only estimated, PI control becomes proportional only. If both algorithms are activated, the PI algorithm has priority over fixed activation, which does not require the ambient temperature and humidity probes. There are a series of conditions whereby the PI algorithm stops operating and, if enabled, fixed activation control takes over.

Condition	Cause
Glass temperature probe not valid	<ul style="list-style-type: none"> • physical probe not configured or faulty; • the estimated glass temperature probe value cannot be used as the outlet probe or intake probe is not configured or is faulty or the ambient probe is broken or absent (*)
Dew point not valid	<ul style="list-style-type: none"> • humidity probe and ambient temperature probe are both not configured or not working; • the serial dew point value is not available

Tab.5.a

(*) If the intake probe is not configured or is faulty, only the outlet probe is used.

PI control

Inputs

The humidity (SU) and ambient temperature (SA) probes may be (see parameters /FL, /FI):

- connected to the Master, which automatically shares them with the Slaves;
- connected locally to each controller;
- sent from the supervisor via the serial probes.

Alternatively, the supervisor can directly supply the dew point value (Sdp) using the serial probes (see parameter /Fn). The glass temperature probe (Svt) can be connected directly to each controller (see parameter /FM), or the value can be estimated. The estimate of the glass temperature probe reading is performed internally when: ambient temperature (SA), outlet temperature (Sm) and intake temperature (Sr) are available, and depends on parameters rHA, rHb and rHS. Parameters rHo, rHd and rHL determine the modulating output.

Code	Description	Def	Min	Max	UOM	User	User terminal
rHS	Virtual probe composition for glass temp. probe estimate 0 = Air off probe Sm 100 = Air on probe Sr	20	0	100	%	S	NO
rHA	Coeff. A for glass temp. probe estimate	2	-20	20	°C/°F	S	NO
rHb	Coeff. B for glass temp. probe estimate	22	0	100	-	S	NO
rHo	Offset for anti-sweat modulation	2	-20	20	°C/°F	S	NO
rHd	Differential for anti-sweat heater modulation	0	0	20	°C/°F	S	NO

If one of the probes is not available (SA or either Sm or Sr), only fixed activation control will be possible, according to parameters rHu and rHt.

Outputs

The percentage of activation (OUT) for anti-sweat heater control depends on the difference between the dew point calculated and the value read by the glass temperature probe, the value of parameter rHo (offset) and the value of parameter rHd (differential), as shown in the following figure. The CUTOFF is a constant of 5°C and the hysteresis is 1°C.

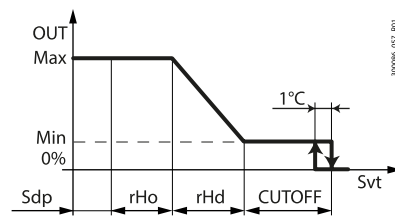

Fig.5.y

Ref.	Description	Ref.	Description
SdP	Dew point	Svt	Glass temperature probe
rHo	Offset for anti-sweat modulation	Min	Minimum fan speed
rHd	Diff. for anti-sweat modulation	Max	Maximum fan speed
OUT	Anti-sweat control		

Min: fixed minimum output of 10%; Max: fixed maximum output of 100%.

The action is proportional only if the estimate of the glass temperature is used, and proportional and integral (Tint=240 s, constant) if the actual glass temperature probe is us. The aim of the integral action is to bring the glass temperature towards the set point (Sdp+rHo).

⚠ Important: if the serial probes from the supervisor are used for sending the ambient temperature and humidity values, MPXone has four auxiliary variables that save the last useful value available for 30 minutes. This may be useful in the event of a supervisor power failure.

Alarms due to probes without updated values are therefore normally shown on start-up, when these variables have not yet been initialised.

Fixed activation control (manual control)

Control depends only on parameters rHu and rHt and follows the trend shown in the figure.

Code	Description	Def	Min	Max	UOM	User	User terminal
rHu	Manual anti-sweat heater activation percentage (of period 'rHt') 0 = function disabled	70	0	100	%	S	NO
rHt	Manual anti-sweat heater activation period 0 = function disabled	5	0	180	min	S	NO

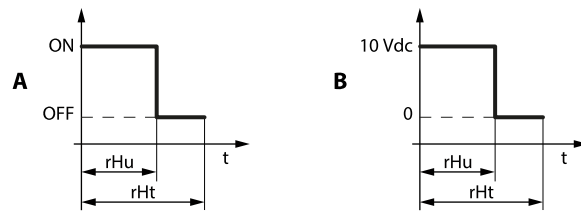

Fig.5.z

Ref.	Description
A	Relay output
B	0-10 Vdc output
rHu	Manual anti- sweat heater activation percentage

Ref.	Description
rHt	Manual anti-sweat heater activation period
t	Time

5.6 Electronic valve

Introduction

MPXone manages an electronic expansion valve using an external driver connected to the Fieldbus port. Using this driver, the following can be set:

- superheat set point;
- type of refrigerant;
- protectors - low superheat (LowSH), maximum evaporation pressure (MOP), minimum evaporation pressure (LOP).

Code	Description	Def	Min	Max	UOM	User	User terminal
P1	Electronic valve type 0 = not used/thermostatic valve 1 = reserved 2 = CAREL E2V valve (suction temp. probe connected) 3, 4, 5 = reserved 6 = CAREL E2V valve (suction temp. probe on external driver)	0	0	6	-	S	YES

MPXone has been designed to manage one electronic expansion valve on one evaporator.

The superheated gas temperature probe and the saturated evaporation temperature probe can be connected directly to MPXone or to the external driver, setting parameter P1 to 2 or 6.

Note:

- see "Introduction" for the models of temperature and pressure probes to be installed;
- CAREL suggests using ratiometric probes to read the evaporation pressure, which is automatically converted to saturated temperature based on specific tables for the type of refrigerant used.

Description of operation

The values read by the probes described above are called:

- tGS = superheated gas temperature;
- tEu = saturated evaporation temperature, converted from the pressure.

Superheat is calculated based on these values:

- $SH = tGS - tEu$

MPXone Medium manages the proportional opening of the electronic expansion valve, adjusting the flow of refrigerant in the evaporator, so as to maintain the superheat around the value set for advanced parameter P3 (superheat set point). The opening of the valve is controlled independently of normal temperature control. When there is a cooling request (the compressor/solenoid valve relay is activated), control of the electronic valve is also activated. If the superheat value read by the probes is greater than the set point, the valve is opened proportionally to the difference between the values. The speed of variation and the percentage of opening depend on the PID parameters set. Opening is continuously modulated based on the superheat value, with PID control.

Note: all the references relating to control of the electronic valve are based on the use of a CAREL E2V electronic expansion valve. The descriptions therefore consider the steps of the stepper motor used

for this type of valve, for example, the maximum number of opening steps is 480.

Refrigerant type (par. PH)

This is used to set the type of refrigerant used in the system. The table below shows the possible types of refrigerant and the associated values of PH. For compatibility with the E2V valve, see the manual for the connected driver. Contact CAREL if installing E2V valves in systems that use refrigerants not listed in the table.

Code	Description						Def	Min	Max	UOM	User	User terminal
PH	Refrigerant						3	0	40	-	S	NO
	0	Custom gas	14	R417A	28	HFO1234ze						
	1	R22	15	R422D	29	R455A						
	2	R134a	16	R413A	30	R170						
	3	R404A	17	R422A	31	R442A						
	4	R407C	18	R423A	32	R447A						
	5	R410A	19	R407A	33	R448A						
	6	R507A	20	R427A	34	R449A						
	7	R290	21	R245Fa	35	R450A						
	8	R600	22	R407F	36	R452A						
	9	R600a	23	R32	37	R508B						
	10	R717	24	HTR01	38	R452B						
	11	R744	25	HTR02	39	R513A						
	12	R728	26	R23	40	R454B						
13	R1270	27	HFO1234yf									

⚠ Important: if the type of refrigerant is incorrect, the superheat measurement will be wrong, with the risk of liquid returning to the compressor.

In addition, a temperature/pressure conversion curve corresponding to an arbitrary new refrigerant can be entered (custom gas) by writing from the supervisor suitable coefficients, a numeric ID for the gas and the CRC protection value. The coefficients are provided by Carel. Once the new refrigerant has been entered, it will be available by setting parameter PH to 0. The value 0 can only be applied if the cyclic redundancy check (CRC) does not detect errors. If the coefficients are modified after having chosen to use a custom refrigerant (PH = 0) and the CRC check fails, alarm GPE will be displayed on the user interface and control will stop.

Superheat set point (par. P3)

Code	Description	Def	Min	Max	UOM	User	User terminal
P3	Superheat set point	10	0	25	K	S	YES

The parameter that electronic valve control is based on is superheat, which effectively tells whether or not there is liquid at the evaporator outlet. Superheat is calculated as the difference between: superheated gas temperature (measured by a temperature sensor located at the end of the outlet tGS) and the saturated evaporation temperature (calculated based on the reading of a pressure transducer located at the evaporator outlet (PEu/tEu) and using the T_{sat}(P) conversion curve for each refrigerant)

SH = superheat (K)

SH = tGS - tEu tGS = superheated gas temperature (°C/°F);

tEu = saturated evaporation temperature, converted from the pressure (°C/°F).

If superheat is high it means that the evaporation process is completed well before the evaporator outlet, and therefore flow-rate of refrigerant through the valve is insufficient. This causes a reduction in cooling efficiency due to the failure to exploit part of the evaporator.



The valve must therefore be opened further. Vice-versa, if superheat is low it means that the evaporation process has not concluded before the end of the evaporator and a certain quantity of liquid will still be present at the compressor suction port. The valve must therefore be closed further. The superheat working range is limited at the lower end: if the flow-rate through the valve is excessive the superheat measured will be near 0 K.

This indicates the presence of liquid, even if the percentage of this relative to the gas cannot be quantified. There is therefore a risk to the compressor. On the other hand, a high superheat value, as mentioned, corresponds to an insufficient flow-rate of refrigerant. Superheat must therefore always be greater than 0 K and have a minimum stable value allowed by the valve-unit system.

A low superheat value in fact corresponds to a situation of probable instability due to the turbulent evaporation process approaching the measurement point of the probes. The expansion valve must therefore be controlled with extreme precision and a reaction capacity around the superheat set point, which will almost always vary from 3 to 14 K. Set point values outside of this range are quite infrequent and relate to special applications. Parameters SH, tGS, tEu and PPU (valve opening percentage) are display only variables, used to monitor the refrigeration process.

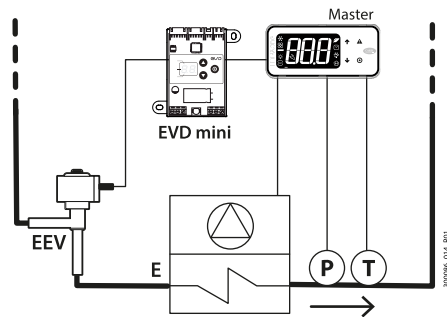

Fig.5.aa

Ref.	Description	Ref.	Description
T	Superheated gas temperature	EEV	Electronic expansion valve
E	Forced-air evaporator	P	Evaporation pressure

MPXone, with PID control, tends to maintain the actual superheat, calculated based on the probe readings, around the value set for this parameter. This is done by gradually varying the opening of the valve based on the difference between the actual superheat and the set point.

⚠ Important: the measured superheat value depends on the quality of the installation, the positioning of the probes and other factors. Depending on the specific installation, the superheat set point may differ from the actual value. Set point values that are too low (2 to 3 K), albeit ideally usable, may cause problems involving the return of liquid refrigerant to the compressor.

Initial valve position when control starts (parameter cP1)

This is used to set the position of the valve as a percentage when control starts. High values ensure intense and immediate cooling of the evaporator when each request is sent, however may cause problems if the valve is oversized with reference to the unit’s cooling capacity. Low values, on the other hand, allow a more gradual and slower action.

Code	Description	Def	Min	Max	UOM	User	User terminal
cP1	Initial valve position when control starts	30	0	100	%	M	NO

Initial valve position maintenance time after defrost (parameter Pdd)

At the end of a defrost, during the dripping phase, the expansion valve can be forced open to the initial value set for cP1 for a time equal to Pdd. This means greater immunity of the unit to return of liquid due to an excessively high evaporator temperature.

Code	Description	Def	Min	Max	UOM	User	User terminal
Pdd	Initial valve position maintenance time after defrost	10	0	30	min	S	NO

Support saturated temperature for pressure probe error (parameter P15)

In the event of a pressure/saturated evaporation temperature probe error, this represents the constant value used by the device to simulate the probe reading. In centralised systems, the evaporation pressure is determined by the compressor rack set point. Once this set point has been set for P15, control can continue, even if not in perfect conditions, in emergency situations.

Code	Description	Def	Min	Max	UOM	User	User terminal
P15	Support saturated temp. for press. probe error	-15	-50	50	°C/°F	M	NO

PID control (parameters P4, P5, P6)

The opening of the electronic valve is controlled based on the difference between the superheat set point and the actual superheat calculated by the probes. The speed of variation, reactivity and the ability to reach the set point depend on three parameters:

- Kp = proportional gain, parameter P4;
- Ti = integral time, parameter P5;
- Td = derivative time, parameter P6;

The ideal values to be set vary depending on the applications and the utilities managed, nonetheless default values are proposed that allow good control in the majority of cases.

For further details, refer to classic PID control theory.

Code	Description	Def	Min	Max	UOM	User	User terminal
P4	Proportional gain	15	0	100	-	S	NO
P5	Integral time 0 = function disabled	150	0	900	s	S	NO
P6	Derivative time 0 = function disabled	5	0	100	s	S	NO

- P4: this represents the amplification factor. It determines an action that is directly proportional to the difference between the set point and the actual superheat value. It acts on the speed of the valve, in terms of steps/°C. The valve moves P4 steps for every degree centigrade variation in superheat, opening or closing whenever the superheat value increases or decreases respectively. It also acts on the other control factors, and is valid in both normal control and with all emergency control functions. High values ==> fast and reactive valve (e.g. 20 for CO₂ - carbon dioxide applications). Low values ==> slow and less reactive valve.
- P5: this represents the time required by the controller to balance the difference between the set point and the actual superheat. In practical terms it limits the number of steps that the valve completes each second. It is only valid during normal control, the special functions in fact have their own integral time. High values==> slow and less reactive valve (e.g. 400 for CO₂-carbon dioxide applications)
Low values ==> fast and reactive valve P5 = 0 ==> integral action disabled
- P6: this represents the reaction of the valve to variations in superheat. It amplifies or reduces variations in superheat.
High values ==> fast variations
Low values ==> limited variations
P6 = 0 ==> differential action disabled
Example: for CO₂ - carbon dioxide applications: P6 = 5

Smooth Lines function

The smooth lines function optimises evaporator capacity based on actual cooling demand, allowing more effective and stable control of the showcase. The function completely eliminates traditional on/off control cycles, modulating the temperature exclusively using the electronic valve; superheat set point is controlled through a precise PI control algorithm based on the actual control temperature. The main features are:

- The superheat set point for managing the electronic expansion valve can vary between a minimum (traditional set point P3) and maximum limit (P3 + PHS: max. offset) using PI control (pre-configured), based on the control temperature and how far this is from the corresponding set point St;
- The temperature inside the showcase can fall slightly below the set point St, without stopping the main control, however simply closing the electronic valve;
- Temperature control (and consequently the solenoid valve relay) therefore remains active at all times, while the electronic expansion valve stops the flow of refrigerant into the evaporator;
- It is easy to use, as it is the controller itself that automatically adapts control based on current operation, without requiring special parameter settings;

The main effects are:

- No swings in temperature and superheat due to the set point being reached;
- Stable temperature and superheat control;
- Maximum energy savings due to load stabilisation.
- Lower dehumidification effect and stable air temperature around the food.

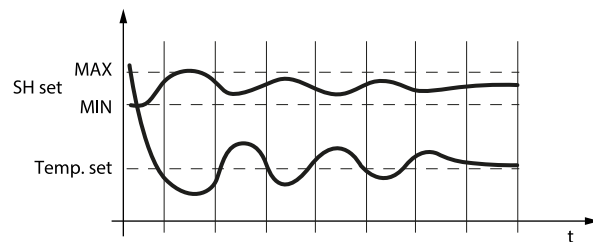

Fig.5.ab

Code	Description	Def	Min	Max	UOM	User	User terminal
PSM	Smooth Lines - enable function	0	0	1	-	S	NO
PLt	Smooth Lines - offset to stop control below set point	2	0	10	°C/°F	S	NO
PHS	Smooth Lines - max superheat offset	15	0	50	K	S	NO

Note: Smooth Lines is not compatible with traditional Floating Suction control, and must be used with the new Rack Smart Set algorithm.

5.6.1 Protection functions

LowSH: low superheat threshold (par. P7)

To prevent too low superheat values that may cause the return of liquid to the compressor or system instability (swings), a low superheat threshold can be defined, below which a special protection function is activated. The LowSH threshold must be lower than the superheat set point. When the superheat falls below the threshold, the system immediately enters low superheat status and activates an integral control action, with the aim of closing the electronic valve more quickly. The low superheat integral time indicates the intensity of the reaction: the lower the value, the more intense the reaction will be. In practice, the intensity of the system's "reaction" is increased. If the device remains in low superheat status for a certain period, a low superheat alarm is activated, with the display showing the message 'LSH', if enabled. The low superheat signal features automatic reset, when the condition is no longer present or the controller is switched off (standby). When low superheat status is activated, the local solenoid valve can be forced closed (parameter P10).

Code	Description	Def	Min	Max	UOM	User	User terminal
P7	LowSH: low superheat threshold	7	-10	P3	K	S	YES
P8	LowSH: integral time 0 = function disabled	15	0	240	s	M	NO

Code	Description	Def	Min	Max	UOM	User	User terminal
P9	LowSH: alarm delay 0 = alarm disabled	600	0	999	s	M	NO
P10	Enable close solenoid valve for low superheat (LowSH) and/or low suction temp. (LSA) 1 = closing enabled	0	0	1	-	M	NO

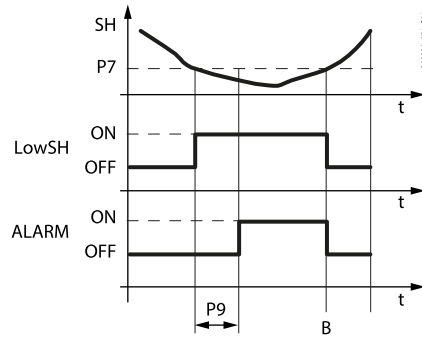

Fig.5.ac

Ref.	Description	Ref.	Description
SH	Superheat	P7	LowSH protection threshold
LowSH	Low superheat protection	P9	Alarm delay
ALARM	Alarm	t	Time

MOP: Maximum evaporation pressure

When starting or restarting a system, the compressors may not be able to satisfy the simultaneous cooling requirements of all the units in the system. This may cause an excessive increase in the evaporation pressure and consequently the corresponding saturated temperature. When the evaporation pressure, expressed in degrees (saturated), rises above the threshold, after a certain settable time the system enters MOP protection status: PID superheat control is stopped and the controller starts gradually closing the valve with an integral action to return the evaporation pressure below the set threshold. The protection function has been designed to allow a gradual return to normal operating conditions, that is, when the critical conditions have ended, the controller temporarily operates with a higher superheat set point until the function is automatically reset.

⚠ Important: if this action causes the complete closing of the electronic valve, the solenoid valve is also closed, even if this is a network solenoid valve, when enabled. The alarm signal with the message 'MOP' on the display is delayed from the activation of the protection function and is automatically reset as soon as the saturated temperature falls below the threshold.

Code	Description	Def	Min	Max	UOM	User	User terminal
PM1	MOP: max saturated evap. temp. threshold	50	-50	50	°C/°F	S	NO
PM2	MOP: integral time	10	0	240	s	M	NO
PM3	MOP: alarm delay 0 = function disabled	0	0	999	s	S	NO
PM4	MOP: function activation delay when starting control	2	0	240	s	M	NO
PM5	MOP: close solenoid valve 0/1 = No/Yes	0	0	1	-	S	NO
PM6	MOP: max suction temp. threshold	50	-50	50	°C/°F	M	NO

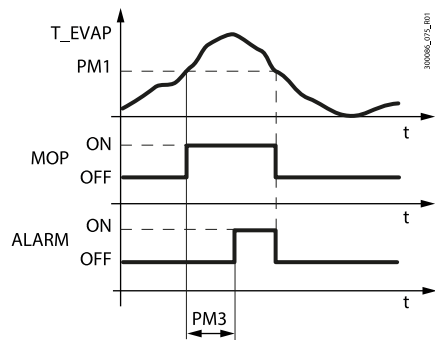

Fig.5.ad

Ref.	Description	Ref.	Description
T_EVAP	Evaporation temperature	PM1	MOP threshold
MOP	MOP protection	PM3	Alarm delay
ALARM	Alarm	t	Time

PM1 represents the maximum evaporation pressure, expressed in degrees (saturated), above which the MOP protection and alarm are activated (each with its own delay times). There is a gradual return to normal operation, to avoid the critical situations arising again.

PM2 represents the integral time for the maximum evaporation pressure protection function. This replaces the normal PID control during MOP status.

PM2 = 0 ==> MOP protection and alarm disabled

PM3 represents the alarm activation delay after exceeding the MOP threshold. When the alarm is activated, the following occur:

- Message 'MOP' shown on the display
- Buzzer activated

The alarm features automatic reset when the evaporation pressure falls below the threshold PM1.

PM4 represents the activation delay MOP protection after the last activation of the solenoid valve.

PM4 = 0 ==> MOP alarm disabled

PM5 allows the local or network solenoid valve (if available), based on the configuration of the system (see parameter r7), to be closed upon activation of the MOP alarm. The solenoid valve is closed if PM5 = 1.

LSA - Low suction temperature

When the suction temperature falls below the threshold, the alarm is activated after the set delay, closing the electronic valve and the local or network solenoid valve (if parameter P10 = 1). The alarm is reset when the suction temperature exceeds the set threshold plus the hysteresis.

Code	Description	Def	Min	Max	UOM	User	User terminal
P10	Enable close solenoid valve for low superheat (LowSH) and/or low suction temp. (LSA) 1 = closing enabled	0	0	1	-	M	NO
P11	LSA: low suction temperature threshold	-45	-50	50	°C/°F	M	NO
P12	LSA: alarm delay 0 = alarm disabled	600	0	999	s	M	NO

P11 represents the suction temperature below which the alarm is activated, after the corresponding delay. The threshold for resetting the alarm is this threshold plus 1°C.

P12 represents the alarm activation delay after exceeding the threshold P11. When the alarm is activated, the following occur:

- message 'LSA' shown on the display;
- buzzer activated

P12 = 0 ==> LSA alarm disabled

P10 allows the network solenoid valve to be closed in the event of low superheat (LowSH) and/or low suction temperature alarm (LSA).

- P10 = 1 (default): the unit that signals the LowSH and/or LSA status, as well as closing the local solenoid valve, broadcasts the request across the LAN. This enables the closing request to be broadcast over the LAN to the Master.

To effectively close the network solenoid valve (if available)(P10=1), the solenoid on the Master must be enabled as a network valve (parameter r7=1), the only type that can accept network requests.

- P10 = 0: the unit that signals the LowSH and/or LSA status does not enable closing of the network and local solenoid valve.

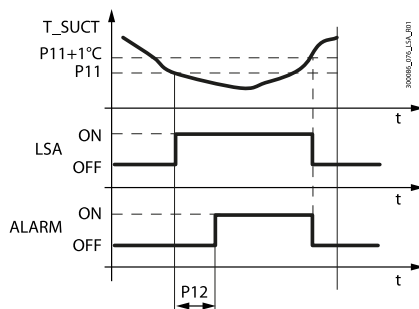

Fig.5.ae

Ref.	Description
T_SUCT	Suction temperature
P11	LSA: low suction temperature threshold
P12	LSA: alarm delay

Ref.	Description
t	Time
LSA	Protection

LOP Minimum evaporation pressure

This function is useful above all for stand-alone refrigeration units, used to prevent the evaporation pressure from remaining excessively low for too long. When the evaporation pressure, expressed in degrees (saturated), falls below the threshold, the LOP protection is activated, which adds an integral action to normal PID control, specifically devised to be more reactive as regards the opening of the valve. The PID control remains active, as superheat must continue to be monitored as to avoid flooding the compressors. The LOP alarm is delayed from the activation of the protection function, both are reset automatically when the pressure value, in degrees (saturated), exceeds the threshold.

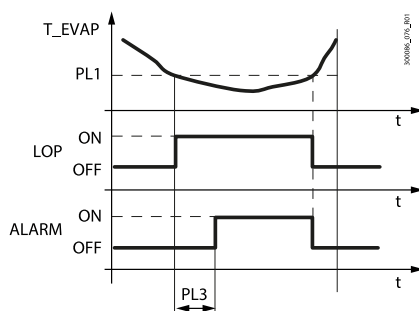

Fig.5.af

Ref.	Description	Ref.	Description
T_EVAP	Evaporation temperature	t	Time
LOP	LOP protection	LOP	Protection
PL3	LOP: alarm delay		

Code	Description	Def	Min	Max	UOM	User	User terminal
PL1	LOP: min saturated evap. temp. threshold	-50	-50	50	°C/°F	M	NO
PL2	LOP: integral time	0	0	240	s	M	NO
PL3	LOP: alarm delay 0 = function disabled	0	0	240	s	S	NO

PL1 represents the evaporation pressure, expressed in degrees (saturated), below which the LOP protection is activated. The protection function is deactivated immediately when the pressure exceeds this threshold.

PL2 represents the integral constant used during activation of the LOP protection function. This integral time acts in addition to normal PID control.

PL2 = 0 ==> LOP protection and alarm disabled

PL3 represents the alarm activation delay after exceeding the LOP threshold. When the alarm is activated, the following occur:

- Message 'LOP' shown on the display;
- Buzzer activated

The alarm features automatic reset when the evaporation pressure rises above the threshold PL1.

PL3 = 0 ==> LOP alarm disabled.

Manual valve positioning

Code	Description	Def	Min	Max	UOM	User	User terminal
PMP	Enable manual expansion valve positioning 0/1 = disabled/enabled	0	0	1	-	S	NO
PMu	Manual valve position	-	0	600	steps	S	NO

PMP is used to enable/disable manual positioning of the valve.

- PMP = 0: manual positioning disabled;
- PMP = 1: manual positioning enabled.

If manual positioning is enabled, this is used to set the manual opening of the electronic valve. The value is expressed in steps.

Read-only variables

Par.	Description	Def.	UOM	Min	Max
PF	Valve opening steps (supervisor)	-	step	-	-
SH	Superheat	-	K	-	-
PPU	Valve opening percentage	-	%	-	-
tGS	Superheated gas temperature	-	°C/°F	-	-
tEu	Saturated evaporation temperature	-	°C/°F	-	-

PF: status variable that only displays, solely from the supervisor, the current position of the electronic valve calculated by the controller. System malfunctions may cause this value to be different from the effective position of the valve.

SH: status variable that only displays the superheat value calculated by MPXone and used to control of valve.

PPU: status variable that only displays the electronic valve opening as a percentage.

tGS: status variable that only displays the evaporator outlet temperature read by the corresponding probe (parameter /Fd).

tEu: status variable that only displays the saturated evaporation temperature calculated by the corresponding evaporation pressure probe or read directly by the NTC probe (advanced parameter /FE).



5.7 Compressor

MPXone features the following compressor protection parameters.

Code	Description	Def	Min	Max	UOM	User	User terminal
d9	Defrost priority over compressor protection times 0/1 = protection times observed/protection times not observed	1	0	1	-	M	NO
c0	Delay to enable solenoid/comp. and evap. fans on power-up	0	0	240	min	M	NO
c1	Min time between consecutive compressor starts	0	0	15	min	M	NO
c2	Min compressor OFF time	0	0	15	min	M	NO
c3	Min compressor ON time	0	0	15	min	M	NO

- c0 is used to delay the start of control when the device is powered on. This is useful in the event of power failures, so that the controllers (in the network) don't all start at the same time, avoiding potential problems of electrical overload. In models with Carel electronic expansion valve and Ultracap technology, this parameter must be set to a value greater than 2.
- c1 sets the minimum time between two successive starts of the compressor, irrespective of the request. This parameter can be used to limit the maximum number of starts per hour;
- c2 sets the minimum compressor off time. The compressor will not be started again until the minimum time set has elapsed;
- c3 sets the minimum compressor running time;
- d9 disables the compressor protection times when defrosting (useful for hot gas defrosts):
 - d9 = 0: protection times are observed;
 - d9 = 1: protection times are ignored, defrosting has higher priority.

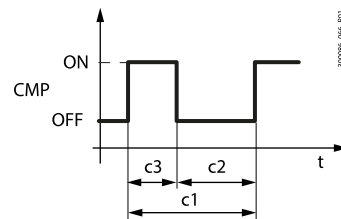

Fig.5.ag

Ref.	Description	Ref.	Description
t	Time	CMP	Compressor

6. Parameter table

Below is the table of the parameters that can be displayed on the terminal or can be modified using the commissioning software or APPLICA app.

The APPLICA app and commissioning tools for MPXone feature three predefined parameter access levels: User (U), Service (S) and Manufacturer (M).

The default passwords to access the Service and Manufacturer parameters from the APPLICA MPXone app are 022 and 044 respectively. The Manufacturer level password also allows access to the Service parameters, and the level S password also allows access to the User parameters.

Par.	Description	Def.	UOM	Min	Max	U
PDM	Manufacturer password	044	-	0	999	S
PDS	Service password	022	-	0	999	S
PDU	User password	-	-	0	999	U

➔ **Note:** the read-only parameters are not visible from the Applica app using NFC, as NFC memory cannot be overwritten frequently.

The MPXone parameters can be reset to the default values by using the procedure described in chapter "installation".

⚠ **Important:** the operation to reset the default values is not reversible, unless a user recipe has been previously saved for loading using the commissioning software/Applica app, see the paragraph on recipes.

6.1 Parameter table

Code	Description	Def	Min	Max	UOM	User	User terminal
Analogue inputs							
/P1	Type of probe, group 1 (S1, S2, S3) 0 = PT1000 Standard Range -50T150 °C 1 = NTC Standard Range -50T90°C	1	0	1	-	S	NO
/P2	Type of probe, group 2 (S4, S5) 1 = NTC Standard Range -50T90°C 2 = 0-5 V 3 = 4-20 mA	2	1	3	-	S	NO
/P3	Type of probe, group 3 (S6) 0 = PT1000 Standard Range -50T150 °C 1 = NTC Standard Range -50T90°C 2 = 0-5 V 3 = 4-20mA 4 = 0-10V	2	0	4	-	S	NO
/FA	Assign air off temp. probe (Sm) 0 = Function disabled	1	-4	6	-	S	NO
	6 = Probe S6						
	1 = Probe S1						
	-1 = Serial probe S11						
	2 = Probe S2						
	-2 = Serial probe S12						
3 = Probe S3							
-3 = Serial probe S13							
4 = Probe S4							
-4 = Serial probe S14							
5 = Probe S5							
/Fb	Assign defrost temperature probe (Sd) - see /FA	2	-4	6	-	S	NO
/Fc	Assign air on temperature probe (Sr) - see /FA	3	-4	6	-	S	NO
/Fd	Assign superheated gas temperature probe (tGS) - see /FA	0	-4	6	-	S	NO
/FE	Assign saturated evaporation pressure/temperature probe (PEu/tEu) - see /FA	0	-4	6	-	S	NO
/FF	Assign defrost temperature probe 2 (Sd2) - see /FA	0	-4	6	-	S	NO
/FG	Assign auxiliary temperature probe 1 (Saux1) - see /FA	0	-4	6	-	S	NO
/FH	Assign auxiliary temperature probe 2 (Saux2) - see /FA	0	-4	6	-	S	NO
/FI	Assign ambient temperature probe (SA) - see /FA	0	-4	6	-	S	NO
/FL	Assign ambient humidity probe (SU) - see /FA	0	-4	6	-	S	NO
/FM	Assign glass temperature probe (Svt) - see /FA	0	-4	6	-	S	NO
/Fn	Assign dewpoint value (SdP) - see /FA	0	-4	6	-	S	NO
/cA	Air off temp. probe (Sm) calibration	0	-20	20	°C/°F	S	NO
/cb	Defrost temp. probe (Sd) calibration	0	-20	20	°C/°F	S	NO
/cc	Air on temp. probe (Sr) calibration	0	-20	20	°C/°F	S	NO
/cd	Superheated gas temperature probe (tGs) calibration	0	-20	20	°C/°F	M	NO
/cE	Saturated evaporation pressure probe (PEu) calibration	0	-20	20	°C/°F	M	NO
/cF	Defrost temp. probe 2 (Sd2) calibration	0	-20	20	°C/°F	S	NO
/cG	Auxiliary temperature probe 1 (Saux1) calibration	0	-20	20	°C/°F	M	NO
/cH	Auxiliary temperature probe 2 (Saux2) calibration	0	-20	20	°C/°F	M	NO
/cI	Ambient temp. probe (SA) calibration	0	-20	20	°C/°F	S	NO
/cL	Ambient humidity probe (SU) calibration	0	-20	20	°C/°F	S	NO
/cM	Glass temperature probe (Svt) calibration	0	-20	20	°C/°F	S	NO
/cn	Dewpoint value (SdP) calibration	0	-20	20	°C/°F	S	NO
/co	Saturated evaporation temperature (tEu) calibration	0	-20	20	°C/°F	M	NO
/UE	Maximum value for saturated evap. pressure/temp. probe (PEu/tEu)	9.3	/LE	200	°C/°F	M	NO
/LE	Minimum value for saturated evap. pressure/temp. probe (PEu/tEu)	0	-1	/UE	°C/°F	M	NO
/UL	Maximum value for ambient humidity probe (SU)	100	/LL	100	%rH	M	NO
/LL	Minimum value for ambient humidity probe (SU)	0	0	/UL	%rH	M	NO

Code	Description	Def	Min	Max	UOM	User	User terminal
/2	Analogue probe measurement stability	4	1	15	-	M	NO
Digital inputs							
DIA	Assign immediate external alarm digital input 0 = Function disabled	0	-1	5	-	S	NO
	1 = digital input 1 (ID1)						
	2 = digital input 2 (ID2)						
	3 = digital input 3 (ID3)						
	4 = digital input 4 (ID4) 5 = digital input 5 (ID5) -1 = digital input seriale						
DIB	Assign delayed external alarm digital input - see DIA	0	-1	5	-	S	NO
DIC	Assign enable defrost digital input - see DIA	0	-1	5	-	S	NO
DID	Assign start defrost digital input - see DIA	0	-1	5	-	S	NO
DIE	Assign door switch with solenoid/comp. and evap. fans OFF digital input - see DIA	0	-1	5	-	S	NO
DIF	Assign remote ON/OFF digital input - see DIA	0	-1	5	-	S	NO
DIG	Assign curtain switch digital input - see DIA	0	-1	5	-	S	NO
DIH	Assign start/stop continuous cycle digital input - see DIA	0	-1	5	-	S	NO
DIJ	Assign input status monitoring digital input - see DIA	0	-1	5	-	S	NO
DIL	Assign timed digital input - see DIA	0	-1	5	-	S	NO
DIM	Assign Standby mode switch digital input - see DIA	0	-1	5	-	S	NO
DIK	Assign Clean mode switch digital input - see DIA	0	-1	5	-	S	NO
DIO	Assign working parameters set change digital input - see DIA	0	-1	5	-	S	NO
DIP	Assign door switch without control stop digital input - see DIA	0	-1	5	-	S	NO
DIR	Assign defrost according to DI status digital input - see DIA	0	-1	5	-	S	NO
rIA	Immediate external alarm digital input logic 0 = direct logic	0	0	1	-	S	NO
	1 = reverse logic						
rIB	Delayed external alarm digital input logic - see rIA	0	0	1	-	S	NO
rIC	Enable defrost digital input logic - see rIA	0	0	1	-	S	NO
rID	Start defrost digital input logic - see rIA	0	0	1	-	S	NO
rIE	Door switch with /solenoid comp. and fans OFF digital input logic - see rIA	0	0	1	-	S	NO
rIF	Remote ON/OFF digital input logic - see rIA	0	0	1	-	S	NO
rIG	Curtain switch digital input logic - see rIA	0	0	1	-	S	NO
rIH	Start/stop continuous cycle digital input logic - see rIA	0	0	1	-	S	NO
rIJ	Input status monitoring digital input logic - see rIA	0	0	1	-	S	NO
rIL	Timed digital input logic - see rIA	0	0	1	-	S	NO
rIM	Standby mode switch digital input logic - see rIA	0	0	1	-	S	NO
rIN	Clean mode switch digital input logic - see rIA	0	0	1	-	S	NO
rIO	Change working parameter configuration digital input logic - see rIA	0	0	1	-	S	NO
rIP	Door switch without control stop digital input - see rIA	0	0	1	-	S	NO
rIR	Defrost according to DI status digital input logic - see rIA	0	0	1	-	S	NO
A9	Select digital input broadcast from Master to Slaves (only on Master) 0 = from supervisor	0	0	5	-	S	NO
	1 = Digital input 1 (ID1)						
	2 = Digital input 2 (ID2)						
	3 = Digital input 3 (ID3) 4 = Digital input 4 (ID4) 5 = Digital input 5 (ID5)						
dIt	Timer duration (timed input) 0 = function disabled	0	0	999	min	S	NO
Digital outputs							
DOA	Assign solenoid/comp. digital output 0 = not set	3	0	4	-	S	NO
	1 = digital output 1 (NO1)						
	2 = digital output 2 (NO2)						
	3 = digital output 3 (NO3) 4 = digital output 4 (NO4)						
DOB	Assign alarm digital output - see DOA	0	0	4	-	S	NO
DOC	Assign auxiliary digital output - see DOA	0	0	4	-	S	NO
DOE	Assign auxiliary serving the Master on the Slaves digital output - see DOA	0	0	4	-	S	NO
DOF	Assign light digital output - see DOA	4	0	4	-	S	NO
DOG	Assign light serving the Master on the Slaves digital output - see DOA	0	0	4	-	S	NO

Code	Description	Def	Min	Max	UOM	User	User terminal
DOG	Assign defrost digital output - see DOA	1	0	4	-	S	NO
DOH	Assign auxiliary evaporator defrost digital output - see DOA	0	0	4	-	S	NO
DOI	Assign evaporator fan digital output - see DOA	2	0	4	-	M	NO
DOo	Assign timed digital output - see DOA	0	0	4	-	M	NO
DOP	Assign drain heater digital output - see DOA	0	0	4	-	M	NO
DOQ	Assign anti-sweat heater digital output - see DOA	0	0	4	-	S	NO
rOA	Solenoid/compressor digital output logic 0/1 = direct/reverse	0	0	1	-	M	NO
rOb	Alarm digital output logic - see rOA	0	0	1	-	M	NO
rOc	Auxiliary digital output logic - see rOA	0	0	1	-	M	NO
rOd	Auxiliary serving the Master on the Slaves digital output logic - see rOA	0	0	1	-	M	NO
rOE	Light digital output logic - see rOA	0	0	1	-	S	NO
rOF	Light serving the Master on the Slaves digital output logic - see rOA	0	0	1	-	S	NO
rOG	Defrost digital output logic - see rOA	0	0	1	-	S	NO
rOH	Auxiliary evaporator defrost digital output logic - see rOA	0	0	1	-	S	NO
rOI	Evaporator fan digital output logic - see rOA	0	0	1	-	S	NO
rOo	Timed digital output logic - see rOA	0	0	1	-	M	NO
rOP	Drain heater digital output logic - see rOA	0	0	1	-	M	NO
H9	Output switched with time bands 0 = Light 1 = AUX	0	0	1	-	S	NO
Analogue outputs							NO
/AA	Assign analogue output for modulating fans 0 = not configured 1 = analogue output 1 (Y1) 2 = analogue output 2 (Y2)	0	0	2	-	M	NO
/Ab	Assign analogue output for modulating valve - see /AA	0	0	2	-	M	NO
/Ac	Assign analogue output for modulating anti-sweat heaters - see /AA	0	0	2	-	M	NO
Control							
ON	ON/OFF control 0/1: OFF/ON	0	0	1	-	S	YES
/4	Virtual probe composition 0 = Air off probe Sm 100 = Air on probe Sr	0	0	100	%	S	NO
r1	Minimum set point	-50	-50	r2	°C/°F	M	NO
r2	Maximum set point	50	r1	50	°C/°F	M	NO
r4	Automatic night set point variation	0	-50	50	°C/°F	S	NO
r6	Probe for night-time control 0/1 = virtual probe Sv/air on probe Sr	0	0	1	-	S	NO
ro	Control offset with probe error	0	0	20	°C/°F	S	NO
r7	Master solenoid valve configuration 0/1 = local valve/network valve (connected to Master)	0	0	1	-	S	NO
St	Set point	50	r1	r2	°C/°F	U	YES
St2	Air on probe set point with double thermostat	50	r1	r2	°C/°F	S	NO
rd	Differential	2	0.1	20	°C/°F	U	YES
rd2	Set point St2 differential with double thermostat 0.0 = function disabled	0	0	20	°C/°F	S	NO
rHS	Virtual probe composition for glass temp. probe estimate 0 = Air off probe Sm 100 = Air on probe Sr	20	0	100	%	S	NO
rHA	Coeff. A for glass temp. probe estimate	2	-20	20	°C/°F	S	NO
rHb	Coeff. B for glass temp. probe estimate	22	0	100	-	S	NO
rHo	Offset for anti-sweat modulation	2	-20	20	°C/°F	S	NO
rHd	Differential for anti-sweat heater modulation	0	0	20	°C/°F	S	NO
rHu	Manual anti-sweat heater activation percentage (of period 'rHt')	70	0	100	%	S	NO

Code	Description	Def	Min	Max	UOM	User	User terminal
	0 = function disabled						
rHt	Manual anti-sweat heater activation period 0 = function disabled	5	0	180	min	S	NO
CLt	Max time for Clean status	0	0	999	min	U	NO
Stt	Maximum time for Standby status	0	0	240	min	S	NO
H14	Time light stays on after closing the door	0	0	240	min	U	NO
dbS	Safety timeout for double thermostat function	0	0	240	min	M	NO
db1	Double thermostat function logic 0/1: AND logic/OR logic	0	0	1	-	M	NO
rSu	Suction valve closing delay in normal control mode	0	0	999	s	S	NO
Defrost							
d0	Type of defrost 0 = heater by temperature 1 = reserved 2 = heater by time 3 = reserved 4 = heater by time with temperature control	0	0	4	-	S	YES
d2	End defrost synchronised by Master 0/1 = not synchronised/synchronised	1	0	1	-	S	NO
d3	Send network start defrost command (for Master) 0/1: yes/no Ignore network start defrost command (for Slave) 0/1: no/yes	0	0	1	-	S	NO
dI	Maximum interval between consecutive defrosts	8	0	240	hours	S	YES
dt1	End defrost temperature (read by Sd)	8	-50	50	°C/°F	S	YES
dt2	End defrost temperature (read by Sd2)	8	-50	50	°C/°F	S	NO
dP1	Maximum defrost duration	45	1	240	min	S	YES
dP2	Max secondary evap. defrost duration	45	1	240	min	S	NO
d4	Defrost on power-up (Master = network defrost; Slave = local defrost) 0/1 = No/Yes	0	0	1	-	S	NO
d5	Defrost delay on power-up or (for Slave) after control from Master 0 = delay disabled	0	0	240	min	S	NO
d6	Display on terminals during defrost 0 = temperature alternating with 'dEF' 1 = freeze display 2 = 'dEF'	1	0	2	-	U	NO
dd	Dripping time after defrost (fans off) 0 = no dripping	2	0	15	min	S	NO
d7	Skip defrost 0/1 = disabled/enabled	0	0	1	-	S	NO
d8	Bypass high temperature alarm time after defrost	30	1	240	min	S	NO
d9	Defrost priority over compressor protection times 0/1 = protection times observed/protection times not observed	1	0	1	-	M	NO
d10	Defrost time in Running time mode 0 = function disabled	0	0	240	min	S	NO
d11	Defrost temperature threshold in Running time mode	-30	-50	50	°C/°F	S	NO
d12	Pressure probe alarm management during defrost						
	probe error						
	supervisor update						
	0 disabled enabled	0	0	3	-	M	NO
	1 enabled enabled						
	2 disabled disabled						
	3 enabled disabled						
dH1	Pump down phase duration 0 = pump down disabled	0	0	999	s	M	NO
dS1	Compressor off time in sequential stop defrost mode 0 = function disabled	0	0	45	min	M	NO

Code	Description	Def	Min	Max	UOM	User	User terminal
dS2	Compressor operating time in sequential stop defrost mode	120	0	240	min	M	NO
ddt	Additional end defrost temperature delta in power defrost mode	0	-20	20	°C/°F	S	NO
ddP	Additional maximum defrost time delta in power defrost mode	0	0	60	min	S	NO
dn	Nominal skip defrost duration	75	0	100	%	S	NO
r3	End defrost signal by timeout 0/1 = disabled/enabled	0	0	1	-	S	NO
c7	Defrost priority over continuous cycle 0/1 = No/Yes	0	0	1	-	M	NO
Defrost scheduling							
td1..8-d	Defrost 1 to 8 - day 0 = event disabled 1 to 7 = Monday to Sunday 8 = from Monday to Friday 9 = from Monday to Saturday 10 = Saturday & Sunday 11 = every day	0	0	11	day	S	NO
td1..8- h	Defrost 1 to 8 - hours	0	0	23	hours	S	NO
td1..8-n	Defrost 1 to 8 - minutes	0	0	59	minutes	S	NO
td1..8-P	Defrost 1 to 8 - enable power defrost: 0/1 = normal/power defrost	0	0	1	-	S	NO
d1S	Number of daily defrosts (td1) 0 = Disabled 1 = 24 ore 0 minutes 2 = 12 ore 0 minutes 3 = 8 ore 0 minutes 4 = 6 ore 0 minutes 5 = 4 ore 48 minutes 6 = 4 ore 0 minutes 7 = 3 ore 26 minutes 8 = 3 hours and 0 minutes 9 = 2 hours and 40 minutes 10 = 2 hours and 24 minutes 11 = 2 hours and 11 minutes 12 = 2 hours and 0 minutes 13 = 1 hour and 0 minutes 14 = 30 minutes	0	0	14	-	S	NO
d2S	Number of daily defrosts (td2) - see d1S	0	0	14	-	S	NO
Evaporator fans							
F0	Evaporator fan management 0 = always on 1 = activation based on Sa - Sb (see FSa and FSb) 2 = activation based on Sa (Sa = first probe, Sb = second probe)	0	0	2	-	S	YES
F1	Evaporator fan activation threshold (only if F0 = 1 or 2)	-5	-50	50	°C/°F	S	YES
F2	Evaporator fans with compressor off 0 = see F0 1 = always off	1	0	1	-	S	NO
F3	Evaporator fans during defrost 0/1 = on/off	1	0	1	-	S	NO
Fd	Post-dripping time after defrost (fans off with control active)	1	0	15	min	S	NO
Frd	Fan activation differential (including variable speed)	2	0.1	20	°C/°F	S	YES
F5	Evap. fan cut-off temperature (hyst. 1°C)	50	F1	50	°C/°F	S	NO
F6	Max evaporator fan speed	100	F7	100	%	M	NO
F7	Min evaporator fan speed	0	0	F6	%	M	NO
F8	Evaporator fan peak time 0 = Function disabled	0	0	240	s	M	NO
F10	Evaporator fan forcing time at max speed 0 = Function disabled	0	0	240	min	M	NO
FSa	First fan control probe 0: Not configured 1: Air off (Sm) 2: Defrost (Sd) 3: Air on (Sr) 4: Superheated gas (tGS) 5: Saturated evaporation pressure (PEu)	3	0	13	-	M	NO

Code	Description	Def	Min	Max	UOM	User	User terminal
	6: Defrost 2 (Sd2) 7: Auxiliary 1 (Saux1) 8: Auxiliary 2 (Saux2) 9: Ambient (SA) 10: Ambient humidity (SU) 11: Glass temperature (Svt) 12: Dewpoint (SdP) 13: Saturated evaporation temperature (tEu)						
FSb	Second fan control probe - see FsA	14	0	14	-	M	NO
Fpd	Evaporator fans during post-dripping 0/1 = On/Off	0	0	1	-	0	NO
POM	Unit cooling capacity indication	4000	0	32000	watts	M	NO
EEV (Electronic expansion valve)							
P1	Electronic valve type 0 = not used/thermostatic valve 1 = reserved 2 = CAREL E2V valve (suction temp. probe connected) 3, 4, 5 = reserved 6 = CAREL E2V valve (suction temp. probe on external driver)	0	0	6	-	S	YES
P3	Superheat set point	10	0	25	K	S	YES
P4	Proportional gain	15	0	100	-	S	NO
P5	Integral time 0 = function disabled	150	0	900	s	S	NO
P6	Derivative time 0 = function disabled	5	0	100	s	S	NO
P7	LowSH: low superheat threshold	7	-10	P3	K	S	YES
P8	LowSH: integral time 0 = function disabled	15	0	240	s	M	NO
P9	LowSH: alarm delay 0 = alarm disabled	600	0	999	s	M	NO
P10	Enable close solenoid valve for low superheat (LowSH) and/or low suction temp. (LSA) 1 = closing enabled	0	0	1	-	M	NO
P11	LSA: low suction temperature threshold	-45	-50	50	°C/°F	M	NO
P12	LSA: alarm delay 0 = alarm disabled	600	0	999	s	M	NO
P14	Enable valve alarm at end travel ('blo') 1 = signal enabled	1	0	1	-	M	NO
P15	Support saturated temp. for press. probe error	-15	-50	50	°C/°F	M	NO
PH	Refrigerant						
	Val.	Desc.	Val.	Desc.	Val.	Desc.	
	0	Custom gas	14	R417A	28	HFO1234ze	
	1	R22	15	R422D	29	R455A	
	2	R134a	16	R413A	30	R170	
	3	R404A	17	R422A	31	R442A	
	4	R407C	18	R423A	32	R447A	
	5	R410A	19	R407A	33	R448A	
	6	R507A	20	R427A	34	R449A	
	7	R290	21	R245Fa	35	R450A	
	8	R600	22	R407F	36	R452A	
	9	R600a	23	R32	37	R508B	
	10	R717	24	HTR01	38	R452B	
	11	R744	25	HTR02	39	R513A	
12	R728	26	R23	40	R454B		
13	R1270	27	HFO1234yf				
PM1	MOP: max saturated evap. temp. threshold	50	-50	50	°C/°F	S	NO

Code	Description	Def	Min	Max	UOM	User	User terminal
PM2	MOP: integral time	10	0	240	s	M	NO
PM3	MOP: alarm delay 0 = function disabled	0	0	999	s	S	NO
PM4	MOP: function activation delay when starting control	2	0	240	s	M	NO
PM5	MOP: close solenoid valve 0/1 = No/Yes	0	0	1	-	S	NO
PM6	MOP: max suction temp. threshold	50	-50	50	°C/°F	M	NO
PL1	LOP: min saturated evap. temp. threshold	-50	-50	50	°C/°F	M	NO
PL2	LOP: integral time	0	0	240	s	M	NO
PL3	LOP: alarm delay 0 = function disabled	0	0	240	s	S	NO
cP1	Initial valve position when control starts	30	0	100	%	M	NO
Pdd	Initial valve position maintenance time after defrost	10	0	30	min	S	NO
dSb	Valve position during defrost 0: as defined by the type of defrost 1: forced closed 2 to 100: opening percentage	0	0	100	%	M	NO
PMP	Enable manual expansion valve positioning 0/1 = disabled/enabled	0	0	1	-	S	NO
PMu	Manual valve position	-	0	600	steps	S	NO
PSM	Smooth Lines - enable function	0	0	1	-	S	NO
PLt	Smooth Lines - offset to stop control below set point	2	0	10	°C/°F	S	NO
PHS	Smooth Lines - max superheat offset	15	0	50	K	S	NO
PSd	Derivative time (Smooth Lines)	0	0	100	s	S	NO
PSI	Integral time (Smooth Lines)	120	0	800	s	S	NO
PSP	Proportional gain (Smooth Lines)	5	0	100	-	S	NO
Solenoid/compressor							
c0	Delay to enable solenoid/comp. and evap. fans on power-up	0	0	240	min	M	NO
c1	Min time between consecutive compressor starts	0	0	15	min	M	NO
c2	Min compressor OFF time	0	0	15	min	M	NO
c3	Min compressor ON time	0	0	15	min	M	NO
c4	ON time for duty setting operation (Toff = 15 minutes fixed) 0 = compressor/valve always OFF 100 = compressor/valve always ON	0	0	100	min	M	NO
cc	Running time in continuous cycle 0 = Disabled	1	0	15	hours	M	NO
c6	Low temp. alarm bypass time after continuous cycle	60	0	240	min	M	NO
Alarms							
A0	High and low temp. alarm reset differential	2	0.1	20	°C/°F	S	YES
A1	Alarm thresholds (AL, AH) relative to the set point St or absolute 0/1 = relative /absolute	0	0	1	-	S	NO
A2	Alarm thresholds (AL2, AH2) relative to the set point St2 or absolute 0/1 = relative /absolute	0	0	1	-	S	NO
A10	Configure solenoid/comp. control during ext. alarm with fixed 15 min OFF time 0 = always OFF 100 = always ON	0	0	14	-	S	NO
A11	Delay time for delayed external alarm 0 = Signal-only alarm	0	0	14	-	S	NO
AA	Assign probe for high (AH) and low (AL) temperature alarms 0: Not configured 1: Air off (Sm) 2: Defrost (Sd) 3: Air on (Sr) 4: Superheated gas (tGS) 5: Reserved	1	0	13	-	S	YES

Code	Description	Def	Min	Max	UOM	User	User terminal
	6: Defrost 2 (Sd2) 7: Auxiliary 1 (Saux1) 8: Auxiliary 2 (Saux2) 9: Ambient (SA) 10: Reserved 11: Glass temperature (Svt) 12: Dewpoint (SdP) 13: Virtual probe (Sv) 14: Saturated evaporation temperature (tEu)						
AA2	Assign probe for high (AH2) and low (AL2) temperature alarms - see AA	5	1	14	-	S	NO
AL	High temp. alarm threshold	4	-50	50	°C/°F	S	YES
AH	Low temp. alarm threshold	10	-50	50	°C/°F	S	YES
AL2	High temp. alarm 2 threshold	0	-50	50	°C/°F	S	NO
AH2	Low temp. alarm 2 threshold	0	-50	50	°C/°F	S	NO
Ad	Delay time for high and low temp. alarms (AH, AL)	120	0	240	min	U	YES
Ad2	Delay time for high and low temp. alarms (AH2, AL2)	30	1	240	min	U	NO
Ar	Signal alarms from Slave to Master 0/1 = not enabled/enabled	1	0	1	-	S	NO
Add	High temp. alarm bypass time for door open	30	1	240	min	U	NO
Htd	HACCP alarm delay 0 = monitoring disabled	0	0	240	min	S	NO
Connectivity							
In	Type of unit 0/1 = Slave/Master	0	0	1	-	S	NO
H0	Serial or Master Slave network address	199	0	199	-	S	YES
H1	BMS serial port config. (stop bits and parity) 0 = 1 stop bit, no parity 1 = 2 stop bits, no parity 2 = 1 stop bit, even parity 3 = 2 stop bits, even parity 4 = 1 stop bit, odd parity 5 = 2 stop bits, odd parity	1	0	5	-	S	YES
H2	BMS serial port baudrate (bit/s) 0 = 1200 1 = 2400 2 = 4800 3 = 9600 4 = 19200 5 = 38400 6 = 57600 7 = 115200	4	0	8	-	S	YES
H3	BMS serial port protocol 0/1 = Carel slave/Modbus slave	1	0	1	-	S	NO
Fieldbus							
Sn	No. of slaves in the local network 0 = no Slaves	0	0	9	-	S	NO
H4	FBus port baudrate (bit/s) 0 = 1200 1 = 2400 2 = 4800 3 = 9600 4 = 19200 5 = 38400 6 = 57600 7 = 115200	4	0	1	-	S	NO
Display							

Code	Description	Def	Min	Max	UOM	User	User terminal
/5	Unit of measure 0/1 = °C/barg/°F/psig	0	0	1	-	S	NO
/6	Display decimal point 0/1 = Yes/No	0	0	1	-	S	NO
/t	Display signals/alarms on remote display 0/1 = Disabled/Enabled	0	0	1	-	S	NO
/t1	Display on user terminal 0 = Terminal disabled 1 to 6 = Probe 1 to 6 7, 8 = Reserved 9 = Control probe 10 = Virtual probe 11 to 14 = Serial Probe 1 to 4 15 = Temperature set point	12	0	18	-	S	NO
/t2	Display on remote display - see /t1	12	0	14	-	S	NO
H5	Enable keypad and NFC functions 0/1 = Disabled/Enabled	1	0	1	-	U	NO
H8	Buzzer 0/1 = No/Yes	1	0	1	-	U	NO
Day/Night							
tS1..8-d	Start time band 1 to 8 day: day - see (td1...8-d)	0	0	11	day	S	NO
tS1..8- h	Start time band 1 to 8 day: hours	0	0	23	hours	S	NO
tS1..8-n	Start time band 1 to 8 day: minutes	0	0	59	minutes	S	NO
tE1..8-d	End time band 1 to 8 day: day - see (td1...8-d)	0	0	11	day	S	NO
tE1..8- h	End time band 1 to 8 day: hours	0	0	23	hours	S	NO
tE1..8-n	End time band 1 to 8 day: minutes	0	0	59	minutes	S	NO

6.2 Configuring the MPXone controller via the APPLICA app

The "Applica" app can be used to configure the controller from a mobile device (smartphone, tablet), via NFC (Near Field Communication) or BLE (Bluetooth Low Energy).

The app is used to configure the commissioning parameters and set groups of preset parameters according to specific needs (recipes).

Procedure:

1. download the CAREL "Applica" app for Android devices from Google Play Store;
2. (on the mobile device) start the app for commissioning the controller;
3. activate NFC and/or BLE;
4. If using an NFC connection: move the device near to the controller, maximum distance 10 mm, to upload the configuration parameters;
5. If using a BLE connection:
 1. select "BLUETOOTH SCAN" to view the MPXone devices available within a range of 10m.
 2. select the device to connect to

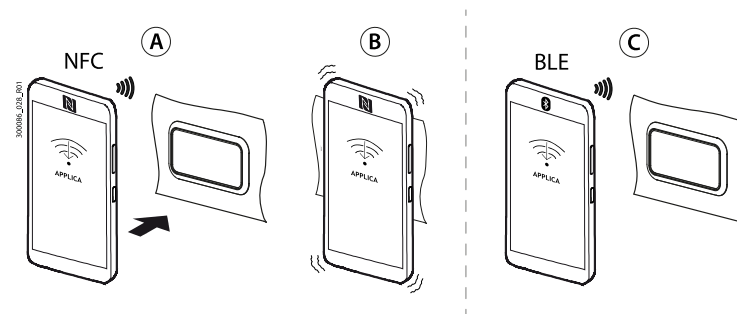

Fig.6.at

Note: during the first connection, the Applica app aligns itself with the software version on the MPXone controller via a cloud connection; this means a mobile data connection is needed at least for this first connection.

Applica makes it easy to set the parameters on the MPXone controller and manage parameter recipes using the hamburger menu at the top left of the screen.

6.2.1 Recipes

Parameter recipes can be created and saved, and then uploaded to the MPXone controller using the configuration software or APPLICA app.

Recipes can be created either using the default values loaded by Carel, or starting from user-set values on the controller MPXone, or alternatively only certain specific values can be modified.

To create a recipe using the configuration software and starting from the default values on the controller, connect the PC to connector J4 BMS (RS485) using converter P/N CVSTDUMOR0, as shown in the figure:

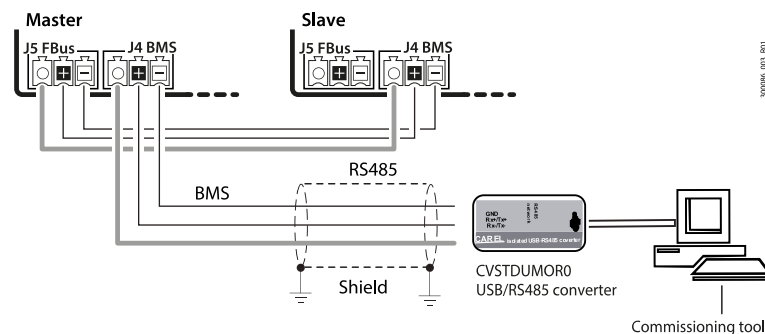

Fig.6.b

Proceed as follows:

1. After starting the configuration software, from the "File" tab open the commissioning file provided by Carel
 2. In the "Target" tab add a "target", i.e. the MPXone controller to communicate with.
 3. Set the type of serial communication and change the connection parameters (default for MPXone baud rate 19200, parity None and 1 stop bit)
 4. Select "Connect".
 5. From the "Configurations" tab, select "Add configuration" (e.g. MyConfiguration1).
 6. After having created and selected the chosen configuration, select "Copy values to configuration".
 7. The "Configuration value" column will now be populated with the current values on the MPXone controller. The values can now be modified to create a custom configuration.
 8. The recipe created as above can be immediately uploaded to the MPXone controller by selecting "Apply configuration" or saved for future use by selecting "Export configuration".
- ➔ **Note:** To create a recipe based on the default values loaded by Carel on the MPXone controller, simply follow the same procedure as described above, and in step 6 select "Apply default values" rather than "Copy values to configuration".

6.2.2 Profiles

Different profiles can be created for displaying the parameters using the configuration software.

Proceed as follows:

1. After starting the configuration software, open the commissioning file provided by Carel;
2. From the "Profiles" tab select "Add profile";
3. Select "Profiling";
4. Select the variables to assign to the profile. These will only be the variables that are visible via the configuration/commissioning software and the Applica app to any M-level user who has the password for profile MyProfile1.
5. Now, selecting profile MyProfile1, the variables to assign to the profile as read-only can be selected by checking the check box in the corresponding column;
6. Select "Edit" to set the password associated with the profile;
7. The profile is now ready to be exported; select "Export profile" and upload it to the cloud service used by the Applica app.

7. Technical specifications

		Panel	Din
Physical specifications	Dimensions	See figures	
	Case	Polycarbonate	
	Mounting	panel	DIN rail
	Ball pressure test temperature	125°C	
	Ingress protection	IP20 rear IP65 front	IP00
	Front cleaning	Use soft, non-abrasive cloth and neutral detergent or water	
Environmental conditions	Operating temperature	-20T60 °C, <90% RH non-condensing	
	Storage temperature	-40T85 °C, <90% RH non-condensing	
Electrical specifications	Rated power supply	24 Vac/dc, use SELV or PELV power supply, Class 2;	115-230 Vac
	Operating power supply voltage	24 Vac/dc, +10% -15%	115-230 Vac, +10% -15%
	Input frequency	50/60Hz	
	Maximum current draw	600 mArms	150 mArms
	Min power consumption	400mW	
	Clock	precision +50ppm; min date/time retention after power off	
		Basic 72 h	Medium 6 months
	Software class and structure	A	
	Environmental pollution class	3	
	Class of protection against electric shock	To be incorporated in class I or II appliances	
	Type of action and disconnection	1.C	
	Rated impulse voltage	115-230V input and relay outputs: 4 kV 24 V input: 0.8 kV	
	Surge immunity category	115-230V input and relay outputs: 3 24 V input: 2	
	Control device construction	Device to be incorporated	
	Terminal block	Plug-in male-female. Cable size: see "Main board: description of the terminals"	
User interface	Buzzer	built-in	not included on the controller, built-in on the user terminal
	Display	built-in, 3 digits, decimal point, and multi-function icons	
Connectivity	NFC	Max distance 10mm, variable according to the mobile device used	not included on the controller, built-in on the user terminal
	Bluetooth Low Energy	Max distance 10m, variable according to the mobile device used	
	BMS serial interface	Modbus RS485, not opto-isolated	
	FieldBUS serial interface	Modbus over RS485, not opto-isolated, maximum number of devices that can be connected: 20	
	HMI interface	not featured	Modbus RS485, not opto-isolated
Analogue inputs (Lmax=10 m)	S1, S2, S3: NTC / PT1000	NTC: resolution 0.1°C; 10kΩ @ 25°C, error:±1°C in the range -50T50°C, ±3°C in the range 50T90°C; PT1000: resolution 0.1°C; 1kΩ @ 0°C; error: ±1°C in the range -60 to +120°C	
	S4, S5: 0-5 Vrat / 4-20 mA / NTC (Medium version)	0...5Vrat: error 2% fs, typical 1%	
	S6: NTC / PT1000 / 0-5 Vrat / 0-10 V / 4-20 mA (Medium version)	4-20 mA: error 5% fs, typical 1% 0-10 V: error 2% fs, typical 1%	
Digital inputs	ID1, ID2, ID3, ID4, ID5	Voltage-free contact, not opto-isolated	

		Panel	Din
		closing current, 6 mA typical open contact voltage 13 V contact resistance max 50 Ω.	
Analogue outputs	Y1, Y2	0-10 V: 10 mA max PWM 100 Hz: max amplitude 10 V: 10 mA max	
Digital outputs	NO1 (16 A), NO2 (8 A), NO3 (5 A), NO4 (5 A) Note: NO1+NO2+NO3 cannot exceed 15 A max.	16 A: EN60730: 15 A resistive, 250 V, 100k cycles; UL60730: 15 A resistive, 240 Vac, 100k cycles; Pilot duty B300, 6k cycles 8 A: EN60730: 5 A resistive, 250 Vac, 100k cycles; 5(4), 250 Vac, 100k cycles; 4(2), 250 Vac, 100k cycles UL60730: 10 A resistive, 250 Vac, 100k cycles; 2 FLA, 12 LRA, 250 Vac, 30k cycles 5 A: EN60730: 5 A resistive, 250 Vac, 50k cycles; 4(1), 230 Vac, 100k cycles; 3(1), 230 Vac, 100k cycles UL60730: 5 A resistive, 250 Vac, 30k cycles; 1 FLA, 6 LRA, 250 Vac, 30k cycles; Pilot Duty C300, 30k cycles	
Probes and terminal power supply	5V	5 Vdc ± 2% to power the 0 to 5 V ratiometric probes. Maximum current delivered: 10 mA protected against short-circuits	
	+V	8-11 V to power the 4-20 mA current probes. Maximum current delivered: 25 mA protected against short-circuits	
	VL	13 Vdc ± 10% to power the remote display	
	HMI power supply	not featured	13 Vdc ± 10% to power the user terminal
Cable lengths	Analogue inputs/outputs, digital inputs/outputs, probe power	<10 m if using the VL power supply in domestic environments, the maximum cable length is 2 m.	<10 m with 115 Vac power supply, if using +V in domestic environments, the maximum cable length is 2 m.
	BMS and Fieldbus serial cables	<500m with shielded cable	
Conformity	Electrical safety	EN/UL 60730-1 EN/UL 60335-1	
	Electromagnetic compatibility	EN 61000-6-1 EN 61000-6-2 EN 61000-6-3 EN 61000-6-4 EAC	
	Applications with flammable refrigerant gases	EN/UL 60079-15 EN/UL 60335-2-34 EN/UL 60335-2-40 EN/UL 60335-2-89	
	Wireless compliance	RED FCC IC	

Tab.7.a

7.1 Connector/cable table

Ref.	Description	Wiring terminals	Wire cross-section (mm ²)	Lmax (m)
J1	Controller power supply	Panel model: plug-in terminal, screw, 2-pin, pitch 5.08	0,5-1,5	10
		DIN rail model: plug-in terminal, screw, 2-pin, pitch 5.08	1,5	10
J2	Inputs S1, S2, S3, S5, ID1, ID2; outputs Y2, Y2	10-pin Microfit crimp connector	0.05- 0.52 (20- 24 AWG)	10
J3	Inputs S4, S6, ID3, ID4, ID5	8-pin Microfit crimp connector	0.05- 0.52 (20- 24 AWG)	10
J4	BMS	Plug-in screw terminal, 3-pin, pitch 3.81	0.081-1.31	500
J5	Fbus	Plug-in screw terminal, 3-pin, pitch 3.81	0.081-1.31	10
J6	Outputs NO1, NO2, NO3, NO4	Digital outputs (16 A, 8 A, 5 A)		10
J7	Output NO5	Digital output (5 A)		10
J8	HMI remote terminal	Coded connection cable (see "Introduction")		

Tab.7.b

8. Alarms and signals

8.1 Signals

The signals are messages shown on the display to notify the user of the control procedures in progress (e.g. defrost) or to confirm keypad input.

Code	Description
dEF	Defrost running
Ed1	Defrost on evaporator 1 ended by timeout
Ed2	Defrost on evaporator 2 ended by timeout
OFF	Switch OFF
Act	Control of Slaves serving Master via LAN
Stb	Standby status
CLn	Clean status

8.2 Types of alarms

There are two types of alarms:

- system: EEPROM, communication, HACCP, high (HI and HI2) and low (LO and LO2) temperature, valve motor alarm;
- control: low superheat (LowSH), low evaporation pressure (LOP), high evaporation pressure (MOP), low suction temperature (LSA).

The EEPROM memory alarm always shuts down the controller. The digital outputs can be configured to signal the alarm status, normally open or normally closed. See "Digital outputs". The controller indicates alarms due to faults on the controller itself, on the probes or in network communication between the Master and Slaves. An alarm can also be activated from an external contact, immediate or delayed. See "Digital inputs". The display shows "IA" and at the same time the alarm icon (triangle) flashes and the buzzer is activated. If more than one error occurs, these are displayed in sequence. A maximum of 5 errors can be saved, in a FIFO list. The error log can be accessed via supervisor or Applica app (BLE connection only).

8.2.1 Active alarms

Active alarms are signalled by the buzzer and the flashing of the ALARM button. Pressing ALARM will mute the buzzer and display the alarm code. Alarm activation is recorded in the alarm log.

If the alarm is reset automatically, the ALARM button goes off, the alarm code is cleared from the list and the alarm reset event is recorded in the alarm log.

Procedure (alarm acknowledgement):

1. press ALARM: the buzzer is muted, the alarm code is shown on the display;
2. press UP/DOWN to scroll through the list of alarms;
3. when finished, press ESC and then PRG to exit.

Example:

Display after HI error.

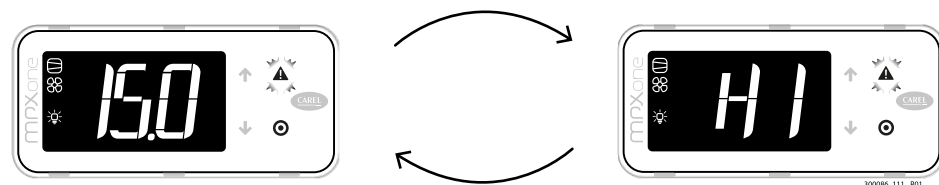

Fig.8.a

A single alarm can be reset by pressing ALARM for more than 3 s. If the condition that generated the alarm is still present, the alarm will be reactivated. The alarm log can be deleted via APPLICA on a

























smartphone, with BLE connection, using the specific function on the alarm page ("Service" level access is required).

Note: deletion of the alarm log is irreversible.

8.3 Display alarm log

The alarm log can only be viewed via the supervisor or APP with BLE connection.

8.4 Alarm table

Display code	Description	Display icon flashing	Alarm relay	Buzzer	Reset	Compressor	Defrost	Evaporator fans	Continuous cycle	Signalled to LAN	Network solenoid valve
rE	Control probe		ON	ON	automatic	duty setting (c4)	unchanged	unchanged	unchanged	YES	NO
E1	Probe S1		OFF	OFF	automatic	duty setting (c4)	unchanged	unchanged	unchanged	YES	NO
E2	Probe S2		OFF	OFF	automatic	unchanged	unchanged	unchanged	unchanged	YES	NO
E3	Probe S3		OFF	OFF	automatic	unchanged	unchanged	unchanged	unchanged	YES	NO
E4	Probe S4		OFF	OFF	automatic	unchanged	unchanged	unchanged	unchanged	YES	NO
E5	Probe S5		OFF	OFF	automatic	unchanged	unchanged	unchanged	unchanged	YES	NO
E6	Probe S6		OFF	OFF	automatic	unchanged	unchanged	unchanged	unchanged	YES	NO
E11	Serial probe S11 not updated		OFF	OFF	automatic	duty setting (c4)	unchanged	unchanged	unchanged	YES	NO
E12	Serial probe S12 not updated		OFF	OFF	automatic	duty setting (c4)	unchanged	unchanged	unchanged	YES	NO
E13	Serial probe S13 not updated		OFF	OFF	automatic	duty setting (c4)	unchanged	unchanged	unchanged	YES	NO
E14	Serial probe S14 not updated		OFF	OFF	automatic	duty setting (c4)	unchanged	unchanged	unchanged	YES	NO
LO	Low temperature		ON	ON	automatic	unchanged	unchanged	unchanged	unchanged	YES	NO
HI	High temperature		ON	ON	automatic	unchanged	unchanged	unchanged	unchanged	YES	NO
LO2	Low temperature		ON	ON	automatic	unchanged	unchanged	unchanged	unchanged	YES	NO
HI2	High temperature		ON	ON	automatic	unchanged	unchanged	unchanged	unchanged	YES	NO
IA	Immediate alarm from external contact		ON	ON	automatic	duty setting (A6)	unchanged	unchanged	unchanged	YES	NO
dA	Delayed alarm from external contact		ON	ON	automatic	duty setting (A6) if A7≠0	unchanged	unchanged	unchanged	YES	NO
dor	Door open for too long		ON	ON	automatic	unchanged	unchanged	unchanged	unchanged	YES	NO
Etc	Real time clock not updated		OFF	OFF	automatic	unchanged	unchanged	unchanged	unchanged	YES	NO
LSH	Low superheat		OFF	OFF	automatic	OFF	unchanged	unchanged	unchanged	YES	YES
LSA	Low suction temperature		OFF	OFF	automatic/manual	OFF (paragraph 6.10)	unchanged	unchanged	unchanged	YES	YES
MOP	Maximum evaporation pressure		OFF	OFF	automatic	OFF	unchanged	unchanged	unchanged	YES	YES
LOP	Low evaporation temperature		OFF	OFF	automatic	unchanged	unchanged	unchanged	unchanged	YES	YES
bLo	Valve blocked		OFF	OFF	manual/disabled when P14=0	unchanged	unchanged	unchanged	unchanged	YES	NO
Edc	Communication		ON	ON	automatic	unchanged	unchanged	unchanged	unchanged	YES	NO

Display code	Description	Display icon flashing	Alarm relay	Buzzer	Reset	Compressor	Defrost	Evaporator fans	Continuous cycle	Signalled to LAN	Network solenoid valve
	error with stepper driver										
HA	HACCP type HA		OFF	OFF	mode	unchanged	unchanged	unchanged	unchanged	YES	NO
HF	HACCP type HF		OFF	OFF	mode	unchanged	unchanged	unchanged	unchanged	YES	NO
MA	Communication error with the Master (only on Slave)		ON	ON	automatic	unchanged	unchanged	unchanged	unchanged	NO	NO
u1...u9	Communication error with the Slave (only on Master)		ON	ON	automatic	unchanged	unchanged	unchanged	unchanged	NO	NO
n1...n9	Alarm on unit 1 to 9 in the network		ON	ON	automatic	unchanged	unchanged	unchanged	unchanged	NO	NO
GPE	Error in the custom gas parameters		ON	ON	automatic	OFF	not performed	OFF	not performed	YES	NO

Tab.8a

8.5 Alarm parameters

Assign probe for high and low temperature alarms (parameters AA, AA2)

AA selects the probe to be used for measuring the high and low temperature alarms with reference to thresholds AL and AH. AA2 is the same as AA for thresholds AL2 and AH2.

Code	Description	Def	Min	Max	UOM	User	User terminal
AA	Assign probe for high (AH) and low (AL) temperature alarms 0: Not configured 1: Air off (Sm) 2: Defrost (Sd) 3: Air on (Sr) 4: Superheated gas (tGS) 5: Reserved 6: Defrost 2 (Sd2) 7: Auxiliary 1 (Saux1) 8: Auxiliary 2 (Saux2) 9: Ambient (SA) 10: Reserved 11: Glass temperature (Svt) 12: Dewpoint (SdP) 13: Virtual probe (Sv) 14: Saturated evaporation temperature (tEu)	1	0	13	-	S	YES
AA2	Assign probe for high (AH2) and low (AL2) temperature alarms - see AA	5	1	14	-	S	NO

Alarm parameters and activation

AL (AH) determines the activation threshold for the low (high) temperature alarm LO (HI). The set value of AL (AH) is continuously compared against the value measured by the probe defined by parameter AA. Parameter Ad represents the alarm activation delay in minutes; the low temperature alarm (LO) is activated only if the temperature remains below the value of AL for a time longer than Ad.

Important:

The thresholds can be relative or absolute, depending on the value of parameter A1:

- A1 = 0: the value of AL indicates the deviation from the set point and thus the activation point for the low temperature alarm is: set point - AL. If the set point changes, the activation point also changes automatically.
- A1 = 1, the value of AL indicates the absolute low temperature alarm threshold. If the set point changes, the activation point remains the same.

The low temperature alarm is signalled by the buzzer and code LO on the display. The same applies to the high temperature alarm (HI), with AH instead of AL.

Note: The meaning of parameters AL2, AH2, AA2, A2 and Ad2 is similar to AL, AH, AA, A1 and Ad however relating to St2.

Code	Description	Def	Min	Max	UOM	User	User terminal
A0	High and low temp. alarm reset differential	2	0.1	20	°C/°F	S	YES
A1	Alarm thresholds (AL, AH) relative to the set point St or absolute 0/1 = relative /absolute	0	0	1	-	S	NO
A2	Alarm thresholds (AL2, AH2) relative to the set point St2 or absolute 0/1 = relative /absolute	0	0	1	-	S	NO
A10	Configure solenoid/comp. control during ext. alarm with fixed 15 min OFF time 0 = always OFF 100 = always ON	0	0	14	-	S	NO
A11	Delay time for delayed external alarm 0 = Signal-only alarm	0	0	14	-	S	NO
AL	High temp. alarm threshold	4	-50	50	°C/°F	S	YES
AH	Low temp. alarm threshold	10	-50	50	°C/°F	S	YES
AL2	High temp. alarm 2 threshold	0	-50	50	°C/°F	S	NO
AH2	Low temp. alarm 2 threshold	0	-50	50	°C/°F	S	NO
Ad	Delay time for high and low temp. alarms (AH, AL)	120	0	240	min	U	YES
Ad2	Delay time for high and low temp. alarms (AH2, AL2)	30	1	240	min	U	NO

Note:

- the LO (LO2) and HI (HI2) alarms are reset automatically. A0 represents the hysteresis between the alarm activation and deactivation value;
- for delayed alarms from digital input (dlb=3, code dA), the contact must remain open for a time greater than A11. When an alarm event occurs, a counter starts and generates an alarm when reaching the minimum time A11. If during the count the value measured returns within the threshold or the contact closes, the alarm is not signalled and the count is reset. When a new alarm condition occurs, the count starts from 0 again. Parameter A10 has a similar meaning to parameter c4 (duty setting). If an external alarm occurs (immediate or delayed) the compressor works for a time equal to the value set for A10 and remains off for a fixed time of 15 minutes.

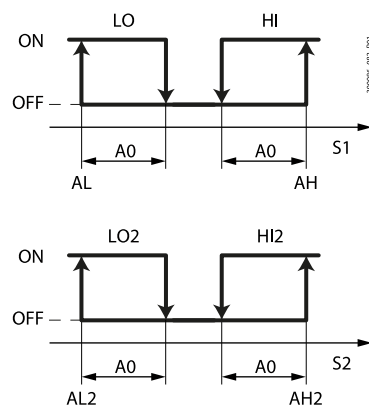

Fig.8.b

Ref.	Description	Ref.	Description
LO, LO2	Low temperature alarms	S1, S2	Probes
HI, HI2	High temperature alarms		

Enable valve alarm at end travel ('blo')

Parameter P14 is used to enable/disable the valve blocked alarm signal ('blo').

Code	Description	Def	Min	Max	UOM	User	User terminal
P14	Enable valve alarm at end travel ('blo') 1 = signal enabled	1	0	1	-	M	NO

Signal alarms from Slave to Master

Master controllers, if Ar=1, can indicate a Slave with an alarm in the LAN. If an alarm occurs on a Slave, the Master shows the signal "nx", alternating with the temperature display, where x is the address of the Slave with the alarm (x=1 to 9). If parameter DOB is set on the Master (value other than zero), then the master alarm relay is also activated.

Code	Description	Def	Min	Max	UOM	User	User terminal
Ar	Signal alarms from Slave to Master 0/1 = not enabled/enabled	1	0	1	-	S	NO

8.6 HACCP alarms

(HACCP = Hazard Analysis and Critical Control Point).

Specific alarms for controlling the operating temperature, recording any anomalies due to power failures or an increase in the temperature due to other causes (breakages, extreme operating conditions, user errors, etc.); see "HACCP alarm parameters and monitoring activation" for details.

Two types of potentially critical HACCP events are managed:

- type HA alarms, high temperature during operation;
example:
The critical temperature was exceeded, the alarm was not managed and the temperature remained above the threshold for longer than the maximum tolerable time. (thresholds defined by site HACCP procedures). The event is critical and potentially hazardous.
- type HF alarms, high temperature after power failure;
example:
The unit was powered off. When restarted, the temperature is above the threshold and does not return to an acceptable level within an appropriate time. (parameters defined by site HACCP procedures). The event is critical and potentially hazardous.

When an alarm occurs, the HACCP LED flashes, the display shows the alarm code, the alarm is logged and the alarm relay and buzzer are activated.

8.6.1 Parameters and monitoring activation

Type HA alarms

The type HA alarm is generated if during normal operation the temperature read by the probe set for parameter AA exceeds the high temperature threshold for the time Ad+Htd. Consequently, compared to the normal high temperature alarm already signalled by the controller, the type HA HACCP alarm is delayed by a further time Htd specifically for HACCP recording.

Code	Description	Def	Min	Max	UOM	User	User terminal
Htd	HACCP alarm delay 0 = monitoring disabled	0	0	240	min	S	NO

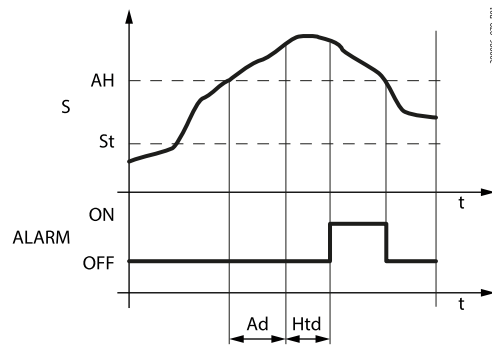

Fig.8.c

Ref.	Description
S	Measurement probe
St	Set point
AH	Low temperature alarm threshold
ALARM	Type HA HACCP alarm
Ad	Delay time for high and low temperature alarms
Htd	HACCP alarm delay 0 = monitoring disabled
t	Time

Ht0 (*)	HACCP alarms present	0	0	1	-	S	NO
HAn (*)	Number of type HA alarms	0	0	15	-	S	NO

Type HF alarms

The type HF HACCP alarm is generated following a power failure for an extended time (> 1 minute), if when power returns the temperature read by probe set for parameter AA exceeds the AH high temperature threshold. HFn indicates the number of type HF alarms activated.

Par.	Description	Def.	Min	Max	UOM	User	User terminal
HFn (*)	Number of type HF alarms	0	0	15	-	S	NO

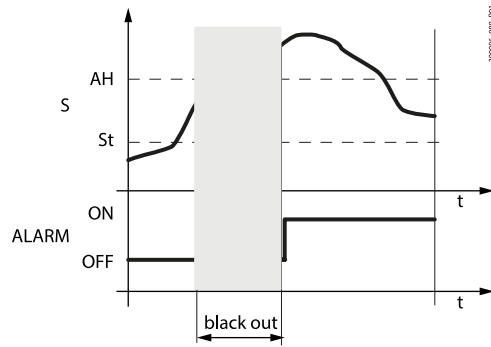

Fig.8.d

Ref.	Description	Ref.	Description
S	Measurement probe	ALARM	Type HA HACCP alarm
St	Set point	t	Time
AH	Low temperature alarm threshold		

(*) parameters visible to supervision or in the APPLICA app.

9. Release notes

Software version	Manual version	Description
1.1	1.0	First release
23-08-2018	04-09-2018	

Tab.9.a

CAREL

CAREL INDUSTRIES S.p.A. - Headquarters

Via dell'Industria, 11

35020 Brugine - Padova (Italy)

Tel. (+39) 049.9716611

Fax (+39) 049.9716600

email: carel@carel.com - www.carel.com

CAREL can accept no responsibility for possible errors in this manual.
CAREL reserves the right to modify its products without notice.